

Foundry



Furnaces and Heat Treatment Plants

Melting
Holding
Core Drying
Thermal Decoring
Dewaxing
Heat Treatment
Additive Manufacturing
Annealing/Tempering
Preheating
Quenching
Energy Efficiency Technology
AMS 2750 E, NADCAP, CQI-9

www.nabertherm.com

■ Made
■ in
■ Germany



Made in Germany

Nabertherm with 500 employees worldwide have been developing and producing industrial furnaces for many different applications for 70 years. As a manufacturer, Nabertherm offers the widest and deepest range of furnaces worldwide. 150,000 satisfied customers in more than 100 countries offer proof of our commitment to excellent design, quality and cost efficiency. Short delivery times are ensured due to our complete inhouse production and our wide variety of standard furnaces.

Setting Standards in Quality and Reliability

Nabertherm does not only offer the widest range of standard furnaces. Professional engineering in combination with in house manufacturing provide for individual project planning and construction of tailor-made thermal process plants with material handling and charging systems. Complete thermal processes are realized by customized system solutions.

Innovative Nabertherm control technology provides for precise control as well as full documentation and remote monitoring of your processes. Our engineers apply state-of-the-art technology to improve the temperature uniformity, energy efficiency, reliability and durability of our systems with the goal of enhancing your competitive edge.

Global Sales and Service Network – Close to you

Nabertherm's strength is one of the biggest R&D departments in the furnace industry. In combination with central manufacturing in Germany and decentralized sales and service close to the customer we can provide for a competitive edge to live up to your needs. Long term sales and partners in all important world markets ensure individual on-site customer service and consultation. There are certainly reference customers who are using similar furnaces or systems close to you.



Large Customer Test Center

Which furnace is the right choice for this specific process? This question cannot always be answered easily. Therefore, we have set up our modern test center which is unique in respect to size and variety. A representative number of furnaces is available for tests for our customers.

Customer Service and Spare Parts

Our professional service engineers are available for you worldwide. Due to our complete inhouse production, we can despatch most spare parts from stock over night or produce with short delivery time.

Experience in Many Fields of Thermal Processing

In addition to furnaces for Foundry, Nabertherm offers a wide range of standard furnaces and plants for many other thermal processing applications. The modular design of our products provides for customized solutions to your individual needs without expensive modifications.

Table of Contents

	Page
Which Furnace for which Process?	4
Melting and Holding Furnaces	
Alternative melting furnace concepts	6
Tilting furnaces KB, gas-fired, for melting and holding	8
Tilting furnaces KBR with recuperative burner, gas-fired, for melting and holding of aluminum	11
Tilting furnaces K, electrically heated, for melting and holding	12
Bale-out furnaces TB, gas-fired, for melting and holding	14
Bale-out furnaces TBR with recuperative burner, gas-fired, for melting and holding	16
Bale-out furnaces T, electrically heated, for melting and holding	18
Tilting furnaces KC and bale-out furnaces TC, SiC-rod heating, for melting	20
Bale-out furnaces T../10, electrically heated, for holding	22
Transportable bale-out furnaces TM, electrically heated, for holding aluminum	23
Bath furnaces B, electrically heated, for holding of aluminum	24
Accessories for bale-out and tilting furnaces	25
Control and documentation alternatives for melting furnaces	27
Melting furnaces in customized dimensions	30
Laboratory melting furnaces, electrically heated	32
Cleaning Furnace for Riser Tubes, Electrically Heated	33
Forced Convection Furnaces	
Chamber ovens, electrically heated or gas-fired	34
Forced convection chamber furnaces, electrically or gas-fired	38
Forced convection bogie hearth furnaces, electrically heated or gas-fired	44
Forced convection pit-type furnaces, electrically heated or gas-fired	46
Pit-type and top-loading furnaces with or without air circulation, electrically heated or gas-fired	47
Forced convection chamber furnaces/dryers with safety technology, for solvent-containing charges according to EN 1539 or NFPA 86	55
Drop-Bottom Furnaces, Electrically Heated or Gas-Fired	48
Quench and Tempering Plants for Steel	50
Quench Tanks	52
Chamber and Bogie Hearth Furnaces	
Chamber furnaces, gas-fired	54
Chamber furnaces for heat cleaning or for processes with high vaporization rates, electrically heated or gas-fired	56
Bogie hearth furnaces, electrically heated or gas-fired	60
Dewaxing Furnaces, Electrically Heated (N../WAX) or Gas-Fired (N../BOWAX)	58
Catalytic and Thermal Post Combustion Systems, Exhaust Gas Washer	64
Continuous Operation Furnaces	
Rotary hearth furnaces to 1300 °C with or without air circulation, electrically heated or gas-fired	66
Continuous furnaces, electrically heated or gas-fired	70
Temperature Uniformity and System Accuracy	74
AMS 2750 E, NADCAP, CQI-9	75
Process Control and Documentation	78
Additive Manufacturing	82
Energy Efficiency Technology	83



Which Furnace for which Process?

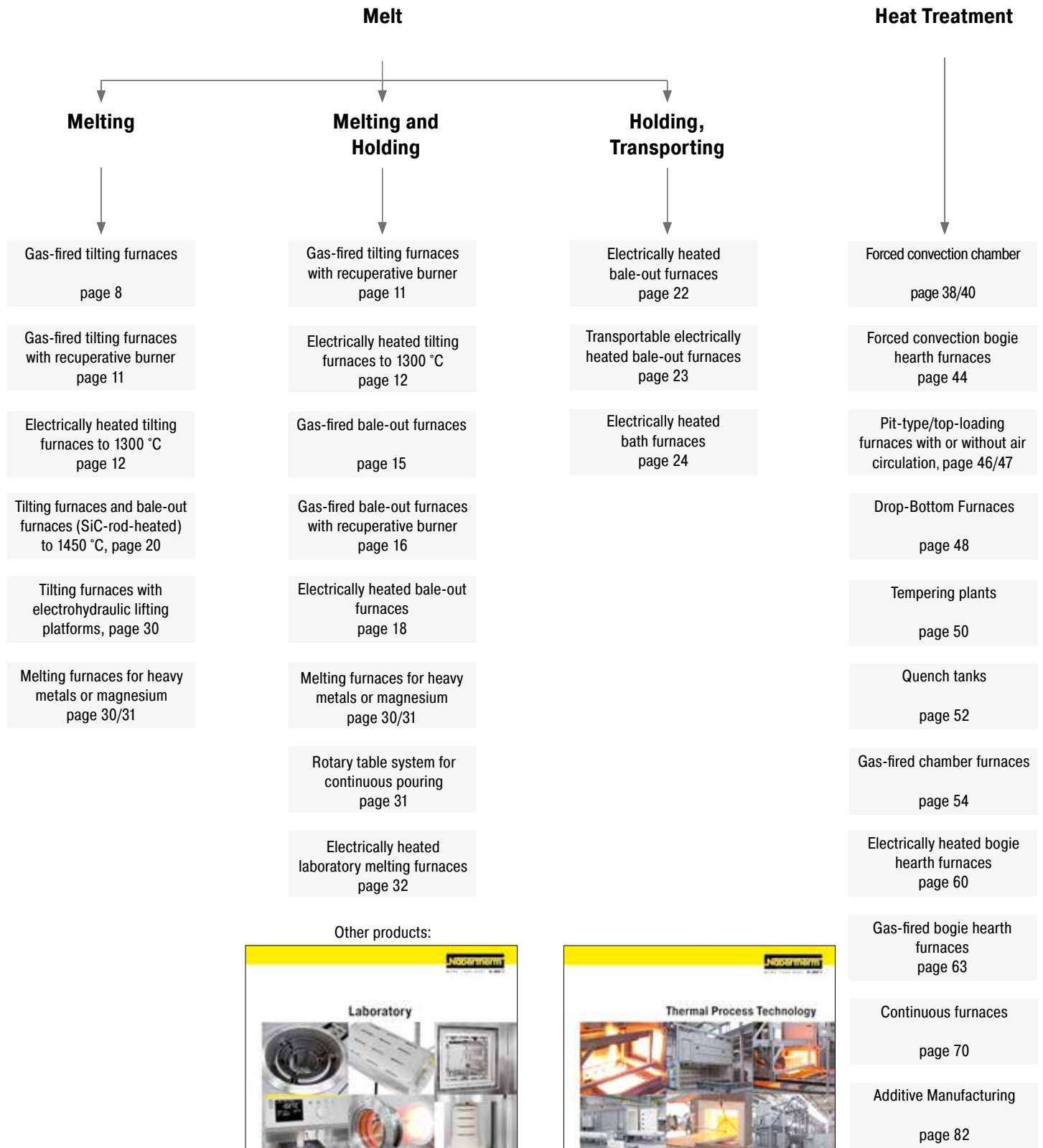

Other products:

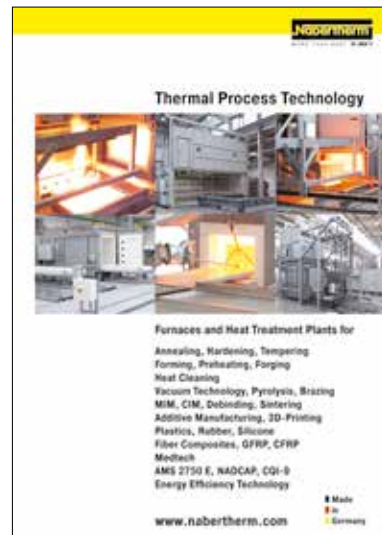

← Other products

Heat Treatment of Forms and Cast Pieces

Dewaxing, Thermal Decoring/Cleaning

Electrically heated cleaning furnaces for riser tubes page 33

Chamber ovens page 34

Forced convection chamber page 38/40

Forced convection bogie hearth furnaces page 44

Chamber ovens, including safety technology according to EN 1539 (NFPA 86), page 55

Gas-fired chamber furnaces for heat cleaning page 56/57

Dewaxing furnaces page 58/59

Pre-Heating, Drying

Chamber ovens, including safety technology according to EN 1539 (NFPA 86), pages 34 + 55

Forced convection chamber page 38/40

Forced convection bogie-hearth furnaces page 44

Pit-type/top-loading furnaces with or without air circulation, page 46/47

Rotary hearth furnaces page 66

Continuous furnaces page 70

Debinding, Sintering



Please order our "Advanced Materials" catalog which contains a large number of solutions for debinding and sintering!

Exhaust Gas Cleaning Systems, Energy Efficiency Concepts

Catalytic post combustion systems page 64

Thermal post combustion systems page 65

Exhaust torch page 65

Energy efficiency technology page 83



Alternative Melting Furnace Concepts

Alternative Heating Technologies

The application of alternative heating technologies depends on the requirements for melt quality, productivity and energy efficiency. In principle either electrically or gas-fired furnaces can be used. In this context, with respect to costs the local pricing for the alternative energy play a decisive role.

Gas-Fired

Gas-fired furnaces are ideal for melting, particularly if equipped with exhaust gas discharge over the crucible edge. Side exhaust gas discharge is best if a high melt quality is required. However, a higher melt quality means a lower energy efficiency since a fuel-fired furnace with side exhaust gas discharge consumes approx. 20-25 % more energy than a furnace with an exhaust gas discharge over the crucible edge.

Fuel-fired furnaces provide for optimal energy efficiency in combination with highest melt quality due to their burner system that includes heat recovery via recuperator. The hot exhaust gases from the furnace preheat the combustion air for the burner via a heat exchanger. This system leads to savings of up to 25 % compared to conventional fuel-fired furnaces with a side exhaust gas discharge.

Electric Heating

If the melt quality and energy efficiency take priority, an electrically heated furnace is the best choice. The heating is controlled very steadily and precisely. The melt is not polluted through immissions from a fuel-fired heating. Electrically heated furnaces can achieve up to 85 % of the melting performance of fuel-fired furnaces with a side exhaust gas discharge. If the furnaces are used only for holding, we recommend the T.../10 models, which are very energy efficient due to their very good insulation and reduced connected load.

Alternative Exhaust Gas Systems

Exhaust Gas Discharge over the Crucible Edge

Exhaust gas discharge over the crucible edge is the standard design for our gas and oil-fired crucible furnaces, except for the TB models for furnace temperatures of 1200 °C, since these furnaces are normally used as holding furnaces. Due to the high melting performance, the furnaces are perfectly suited for melting. This type of exhaust gas discharge is characterised as follows:

- + Very high melting performance, ideal for use as a melting furnace
- + Low power consumption since the crucible is not just heated from the outside but part of the heat also enters the crucible from above. Energy savings of up to 20 % compared to furnaces with a side exhaust gas discharge
- Limitations on the melt quality due to higher burn-off and increased hydrogen absorption by the melt from the exhaust gases
- Bath control not recommended

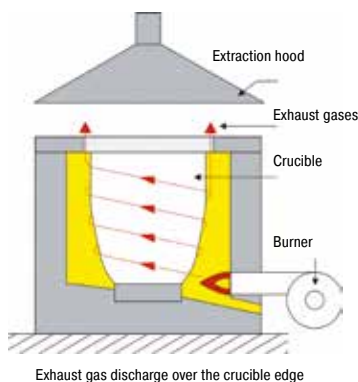

Side Exhaust Gas Discharge

a) without Recuperator Technology

The side exhaust gas discharge is available for all fuel-fired crucible furnaces. Although the melting performance is not as high as with an exhaust gas discharge over the crucible edge, it provides for better melt quality and, in combination with a bath control, is highly recommended for holding operation.

- + High melt quality due to low burn-off and reduced hydrogen inclusions in the melt
- + Swing lid-reduction of power consumption up to 50 % during holding with a closed swing lid
- + Operator exposed to less heat in the area above the crucible
- + Best melt quality if a bath control for precise temperature control is used
- Lower melting performance compared to furnaces with exhaust gas discharge over the crucible edge
- Power consumption during melting around 25 % higher compared to furnaces with exhaust gas discharge over the crucible edge

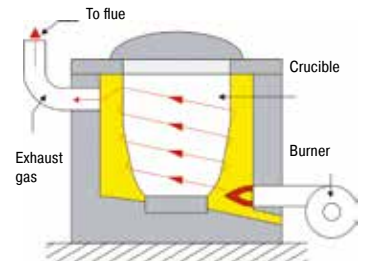

Side exhaust gas discharge

b) with Recuperator Technology

Fuel-fired furnaces with burner systems that include heat recovery via a recuperator provide for optimum energy efficiency in connection with a top melt quality. The combustion air for the burner is pre-heated with the hot exhaust gases from the furnace via heat exchanger. The system results in savings of up to 25 % compared to conventional fuel-fired furnaces with side exhaust gas discharge.

Depending on the utilisation the relatively higher acquisition costs pay off already after a short period of time.

- + Burner systems with a recuperator system save around 25 % of the power compared to furnaces with a side exhaust gas discharge
- + High melt quality due to low burn-off and reduced hydrogen absorption in the melt
- + Reduced power consumption by up to 50 % during holding with a closed swing lid
- + Operator exposed to less heat in the area above the crucible
- + Best melt quality if a bath control for a precise temperature control is used
- Lower melting performance than furnaces with exhaust gas discharge over the crucible edge
- Power consumption during melting around 20-25 % higher than furnaces with exhaust gas discharge over the crucible edge

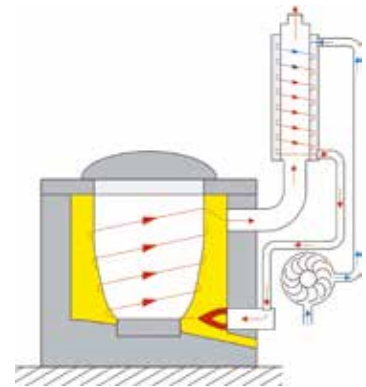

Side exhaust gas discharge with recuperator technology

Decision Aid for Melting Furnaces

	Use	Productivity	Melt Quality	Energy Consumption	Noise Emissions
Models TB/KB (not for models TB ../12) Exhaust gas discharge over the crucible edge	Melting	++	-	0	-
Models TB/KB Side exhaust gas discharge	Melting + Holding	+	+	-	-
Models TBR/KBR Side exhaust gas discharge with recuperator	Melting + Holding	+	+	+	-
Models T/K Electrically heated with bath control	Melting + Holding	0	+++	++	+
Models T/K Electrically heated without bath control	Melting + Holding	0	++	++	+
Modelle T../10 Electrically heated with bath control	Holding	-	+++	+++	+
Models TC/KC Electrically heated via SiC rods	Melting + Holding	+	+	0	+

Tilting Furnaces KB

Gas-Fired, for Melting and Holding



Tilting furnace KB 400/12 with exhaust gas discharge over the crucible edge



Hydraulic system with flame resistant hydraulic fluid

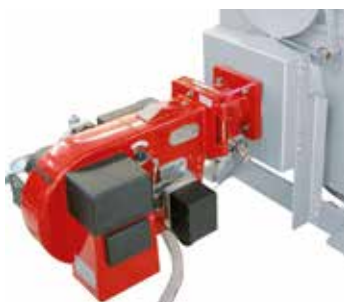

Two-stage burner, mounted on furnace frame

The gas-fired or oil-heated tilting furnaces in the KB product lines provide for high melting performance, making them ideal for melting operations. The use of high-quality insulation materials results in very low energy consumption. The two-stage burner can be configured for either gas or oil operation. Designed with an exhaust vent over the crucible edge, these tilting furnaces achieve very high melting rates and optimum energy efficiency.

Models KB ../12 reach a max. furnace temperature of 1200 °C resulting in melting temperatures of up to 1050 °C. These tilting furnaces are mainly used for aluminum and Zinc alloys.

Models KB ../14 reach a max. furnace temperature of 1400 °C resulting in melting temperatures of up to 1250 °C. These tilting furnaces are mainly used for copper alloys in small foundries.

Standard Design for all Tilting Furnaces

- Two-stage output control: High load for melting operation, low load for holding operation with automatic switching between both modes
- Modern burner system with optimized flame guide: High efficiency provided by over-pressure operation to keep out entrained air
- Gas system consisting of pressure regulator, gas filter, manometer and solenoid valves
- Safe flame monitoring
- Burner technology with easy-to-service design, e.g. flame head can be removed from the rear when the burner is swung out
- Burner technology compliant with DIN 746, Part 2
- Designed for natural gas or liquid natural gas with 8.8 kWh/m³ - 25.9 kWh/m³
- Required min. gas pressure with full load: 50 mbar
- Operation with other fuels and/or with another gas input pressure possible
- High melting performance powered by high-performance burners and high-quality insulation
- Incl. crucible
- Electro-hydraulic tilting system with flame resistant HFC hydraulic fluid



Melting furnace plant consisting of two tilting furnaces KB 360/12 with side exhaust gas discharge and one work platform

- Safe, uniform and precise pouring enabled by the optimum pivot point of the furnace and the manual operation of the slider valve
- Multi-layered insulation with lightweight refractory bricks
- Exhaust gas discharge over the crucible edge see page 6 - 7
- Emergency outlet for safe discharge of the melt in case of a crucible break
- Only fiber materials are used which are not classified as carcinogenic according to TRGS 905, class 1 or 2
- Over-temperature limiter for the furnace chamber with automatic reset to protect against over-temperature. The limit controller switches off the heating when the pre-set limit temperature has been reached and does not switch it on again until the temperature falls below the setting again.
- Furnace chamber control with temperature measurement behind the crucible, recommended when using as pre-melt furnace
- Information about temperature control see page 27 - 29
- Defined application within the constraints of the operating instructions



Tilting furnace KB 240/12 for melting aluminum alloys

Standard Design for Tilting Furnaces KB ../14

- Insulation with an additional wear-and-tear layer made of copper-resistant refractory concrete

Additional Equipment for all Tilting Furnaces

- Work platform or platform for easier charging
- Collecting pan under the emergency outlet see page 26
- Process control and documentation via Nabertherm Control Center (NCC) for monitoring, documentation and control see page 27
- Information on other accessories see page 25 - 26



Insulated connecting piece for side-wall exhaust gas vent to a connected customer suction system



Tilting furnace KB 150/12 in production

Additional Equipment for Tilting Furnaces KB ../12

- Side exhaust gas discharge see pages 6 - 7
- Swing lid (only when equipped with side exhaust gas discharge)
- Crucible breakage monitoring with optical and acoustic signal
- Insulated connecting piece (exhaust flue) for side-wall exhaust gas vent to a connected customer suction system
- SMS-alarm message to one or more mobile phones, e.g. in case of crucible breakage
- Bath control system (only when equipped with side exhaust gas discharge) see page 28
 - Furnace control via the bath temperature
 - Thermocouples in the furnace chamber and the melt
 - Improved melt quality ensured by a reduction in temperature overshoots
 - Integrated safety controller system that, in case of bath thermocouple breakage, continues to operate the furnace at a reduced output to prevent the melt from solidifying

Model	Tmax furnace °C	Tmax melt bath °C	Crucible	Capacity		Burner output kW	Melting performance ³		Consumption Melting kWh/kg	Consumption Holding Lid closed kWh/h	Outer dimensions ⁴ in mm			Weight in kg
				kg Al	kg Cu		kg/h Al	kg/h Cu			W ⁵	D	H	
KB 80/12	1200	1050	TP 287	180	550	300	220 ¹	-	Al 1,3 - 1,5	10	2730	1530	1680	2100
KB 150/12	1200	1050	TP 412	330	970	300	240 ¹	-	1,0 - 1,3	11	2830	1630	1880	2600
KB 180/12	1200	1050	TP 412 H	370	1200	300	260 ¹	-	1,0 - 1,3	13	2830	1630	1980	2800
KB 240/12	1200	1050	TP 587	570	-	390	400 ¹	-	1,0 - 1,3	15	3120	1840	1980	3100
KB 360/12	1200	1050	TBN 800	750	-	450	420 ¹	-	1,0 - 1,3	17	3170	1890	2080	3300
KB 400/12	1200	1050	TBN 1100	1000	-	450	450 ¹	-	1,0 - 1,3	19	3170	1890	2150	3600
KB 40/14	1400	1250	R 400/TP 982	120	400	400	-	330 ²	Cu 1,0 - 1,3	22	2070	1440	1890	2300
KB 60/14	1400	1250	R 500	150	500	400	-	360 ²	1,0 - 1,3	25	2140	1440	1990	2500
KB 80/14	1400	1250	R 600	180	600	400	-	380 ²	1,0 - 1,3	25	2140	1440	2110	2650

¹At 700 °C

³The stated melting performances are maximum values. Daily operation comes up to roughly 80 %.

⁴External dimensions vary when furnace is equipped with additional equipment. Dimensions on request.

²At 1000 °C

⁵Incl. burner

Tilting Furnaces KBR with Recuperative Burner Gas-Fired, for Melting and Holding of Aluminum

The fuel-heated tilting furnaces with the side exhaust gas discharge provide for optimum energy utilization combined with highest quality melt. Fitted with a burner system including heat-recovery system using a recuperative burner, the energy efficiency of fuel-heated tilting furnaces is significantly improved.

Depending on utilization the exhaust gases from the crucible furnace are guided through a heat exchanger in order to preheat the combustion air for the burner. The system provides for energy savings of up to 25 % compared to conventional fuel-heated tilting furnaces with side exhaust gas discharge. The higher purchase costs are amortized within a short time.

The KBR series is recommended when both high melt quality requirements and high energy efficiency are required, and the speed of the melting process is of secondary interest. If the fastest possible melting rate is important for the process and a particularly high quality of the melt is of secondary importance, a conventional tilting furnace KB with exhaust ducting over the edge of the crucible (see page 8) is recommended.

Technical Design as Models KB (See Page 8) but with the Following Features

- Heat exchanger in the exhaust gas duct to preheat the combustion air for the burners
- Energy savings of up to 25 % in comparison to other fuel-heated melting furnaces featuring side-wall exhaust gas vents
- Side exhaust gas discharge
 - Low burn-off provides for high quality melt
 - Low hydrogen absorption by the melt
 - Low heat exposure for the operator in the area above the crucible
- Max. furnace temperature of 1100 °C for melt bath temperatures up to 950 °C
- Required minimum gas pressure at full load: 80 mbar



Tilting furnace KBR 240/11



Tilting furnace KBR 240/11 during filling of a transport ladle

Model	Tmax furnace °C	Tmax melt bath °C	Crucible	Capacity kg Al	Burner output kW	Melting performance ² kg/h Al ¹	Consumption Melting kWh/kg	Consumption Holding Lid closed kWh/h	Outer dimensions ³ in mm			Weight in kg
									W ⁴	D	H	
KBR 240/11	1100	950	TP 587	570	390	320	Al 1,1 - 1,4	13	2580	2300	1980	3600
KBR 360/11	1100	950	TBN 800	750	450	340	1,1 - 1,4	15	2580	2350	2080	3800
KBR 400/11	1100	950	TBN 1100	1000	450	360	1,1 - 1,4	16	2580	2350	2150	4100

¹At 700 °C

²The stated melting performances are maximum values. Daily operation comes up to roughly 80 %.

³External dimensions vary when furnace is equipped with additional equipment. Dimensions on request.

⁴Incl. burner

Tilting Furnaces K

Electrically Heated, for Melting and Holding



Tilting furnace K 150/12



Tilting furnace K 150/12 and bale-out furnace T 180/11 as premelting and holding system



Charging of transport ladle with tilting furnace K 360/12



Tilting furnace K 40/13 with extended spout (sculpture foundry Knaak)

The electrically heated tilting furnaces are characterized by high melting performance with very temperature uniformity in the melt. Aluminum and brass can be melted in the 1200 °C version. The 1300 °C version can also be used to melt bronze alloys.

- K ../12 with Tmax of 1200 °C also suitable for aluminum or brass, with a maximum melt bath temperature, depending on the condition of the crucible, of 1050 °C
- K ../13 with Tmax of 1300 °C also suitable for bronze alloys or brass, with a maximum melt bath temperature of 1150 °C
- Heating from three sides using electric heating elements, radiating freely on support tubes, simple exchange of individual heating elements
- Multi-step wiring of the heating elements for furnaces with more than 50 kW electrical rating
- Heating of furnaces up to 60 kW power rating controlled using long-lasting, noiseless solid-state-relays
- Heating of furnaces beyond 60 kW with contactors
- High melting performance with temperature uniformity in the melt
- Insulation constructed in multiple layers with lightweight refractory bricks on the hot face
- Incl. crucible
- Electro-hydraulic tilting system with flame resistant HFC hydraulic fluid
- Safe, even, and precise pouring thanks to optimum pivot point in the furnace and manual throttling valve operation
- Emergency outlet for safe draining of the melt in case of crucible breakage
- Only fiber materials are used which are not classified as carcinogenic according to TRGS 905, class 1 or 2
- No exhaust gas discharge needed
- Integrated safety system which continues to operate the furnace at reduced power in case of malfunction in the bath thermocouple, in order to prevent the freezing of the melt
- Over-temperature limiter in furnace chamber for protection against overheating. The limiter switches the heating off when the set limit temperature is reached, and only switches it back on after the temperature has fallen again
- Furnace chamber control with temperature measurement behind the crucible, recommended for melting
- Information on temperature regulation see page 27 - 29
- Defined application within the constraints of the operating instructions



3 tilting furnaces K 300/12 with work platform for melting of aluminum

Additional equipment

- Work platform for easy charging
- Collecting pan under the emergency outlet see page 26
- Crucible breakage monitor with visual and audible signal (only for models K ../12)
- SMS-message to one or more mobile phones in case of crucible breakage. One or more furnaces can be connected to the messaging device in parallel
- Bath control with thermocouples in the furnace chamber and in the melt. The furnace temperature is controlled through the melt. Temperature overshoots are reduced, thus the quality of the melt is improved
- Heating system operated through thyristors in phase-angle mode provides for even load on the heating elements and results in longer service life
- Multi-step switching of the furnace heat (see page 27). In holding mode, a switch or the controller is used to turn off one heating section in order to reduce the electrical rating
- Higher electrical ratings to increase melting performance
- Process control and documentation via Nabertherm Control Center (NCC) for monitoring, documentation and control see page 27
- For information on other accessories see page 25 - 26



Filling a mould with liquid bronze (photographer Andrea Künstle)

Model	Tmax furnace	Tmax melt bath	Crucible	Capacity		Heating power in kW ⁴	Melting performance ³		Consumption Holding Lid closed/open kWh/h	Outer dimensions ³ in mm			Weight in kg
	°C	°C		kg Al	kg Cu		kg/h Al	kg/h Cu		W	D	H	
K 10/12	1200	1050	A 70	20	70	16	32 ¹	47 ²	3/7 ¹	1890	1240	1390	950
K 20/12	1200	1050	A 150	45	150	20	42 ¹	63 ²	3/7 ¹	1890	1400	1410	1400
K 40/12	1200	1050	A 300	90	300	26	58 ¹	84 ²	3/7 ¹	2000	1450	1490	1550
K 80/12	1200	1050	TP 287	180	550	50	126 ¹	190 ²	4/10 ¹	2050	1520	1580	1750
K 150/12	1200	1050	TP 412	330	970	60	147 ¹	220 ²	5/12 ¹	2120	1600	1860	2350
K 180/12	1200	1050	TP 412H	370	1200	60	160 ¹	240 ²	5/12 ¹	2120	1600	1860	2450
K 240/12	1200	1050	TP 587	570	-	80	180 ¹	-	8/17 ¹	2260	1760	1860	2800
K 300/12	1200	1050	TP 587H	650	-	80	210 ¹	-	9/18 ¹	2260	1760	1960	3200
K 360/12	1200	1050	BUK 800	750	-	100	260 ¹	-	11/20 ¹	2370	1810	1950	3500
K 400/12	1200	1050	TBN 1100	1050	-	126	295 ¹	-	12/22 ¹	2370	1930	2100	3700
K 10/13	1300	1150	A 70	20	70	16	32 ¹	47 ²	5/8 ²	1890	1240	1440	1000
K 20/13	1300	1150	A 150	45	150	20	42 ¹	63 ²	5/8 ²	1890	1400	1460	1300
K 40/13	1300	1150	A 300	90	300	26	58 ¹	84 ²	5/8 ²	2000	1450	1540	1650
K 80/13	1300	1150	TP 287	180	550	50	126 ¹	190 ²	6/11 ²	2050	1520	1580	1950

¹At 700 °C

²At 1000 °C

³The specified melting performances are maximum values. In practice, approx. 80 % are achieved.

⁴Depending on furnace design connected load might be higher

⁵External dimensions vary when furnace is equipped with additional equipment. Dimensions on request.

Bale-Out Furnaces TB

Gas-Fired, for Melting and Holding



Bale-Out Furnace TB 20/14

The gas-fired or oil-heated bale-out furnaces of the TB product lines provide for high melting performance. The use of modern burner systems, optimized pressures and flame guide in the furnace as well as the processing of high-quality insulation materials result in very low energy consumption.

The TB ./12 reach a max. furnace chamber temperature of 1200 °C resulting in melting temperatures up to 1050 °C. These bale-out furnaces are mainly used for melting and holding of aluminum and zinc alloys, for example in die-cast foundries. The side exhaust gas discharge provides for a high quality melt.

The TB ./14 models reach a max. furnace chamber temperature of 1400 °C resulting in max. melting temperatures of up to 1250 °C. These bale-out furnaces are mostly used for melting copper alloys in small foundries. This is why these bale-out furnaces are standardly equipped with an exhaust gas vent over the crucible edge for high melting rates. Models TB 10/14 and TB 20/14 are standardly equipped with a collar plate that can be swung aside for crucible pulling.



Thermocouple for melt bath control

Standard Design for all Bale-Out Furnaces

- Two-stage output control: High load for melting operation, low load for holding operation with automatic switching between both modes
- Modern burner system with optimized flame guide: High efficiency provided by over-pressure operation to keep out entrained air
- Gas system consisting of pressure regulator, gas filter, manometer and solenoid valves
- Safe flame monitoring
- Burner technology with easy-to-service design, e.g. flame head can be removed from the rear when the burner is swung out
- Burner technology compliant with DIN 746, Part 2
- Designed for natural gas or liquid natural gas with 8.8 kWh/m³ - 25.9 kWh/m³
- Required min. gas pressure with full load: 50 mbar
- Operation with other fuels and/or with another gas input pressure possible
- High melting performance powered by high-performance burners and high-quality insulation
- Multi-layered insulation with lightweight refractory bricks
- Emergency outlet for safe discharge of the melt in case of a crucible break
- Only fiber materials are used which are not classified as carcinogenic according to TRGS 905, class 1 or 2
- Over-temperature limiter for the furnace chamber with automatic reset to protect against over-temperature. The limit controller switches off the heating when the pre-set limit temperature has been reached and does not switch it on again until the temperature falls below the setting again.
- Furnace chamber control with temperature measurement behind the crucible, recommended when using as pre-melt furnace
- Information about temperature control see page 27 - 29
- Defined application within the constraints of the operating instructions



Emergency outlet for safe melt discharge in case of crucible break

Standard Design for Bale-Out Furnaces TB ../12

- Side exhaust gas discharge see pages 6 - 7
- Swing lid

Standard Design for Bale-Out Furnaces TB ../14

- Insulation with an additional wear-and-tear layer made of copper-resistant refractory concrete
- Exhaust gas discharge over the crucible edge see page 6 - 7
- Swinging collar plate for crucible pulling for bale-out furnaces to TB 10/14 - TB 20/14 (not possible for larger models)

Additional Equipment for All Bale-Out Furnaces

- Work platform or platform for easier charging
- Collecting pan under the emergency outlet see page 26
- Process control and documentation via Nabertherm Control Center (NCC) for monitoring, documentation and control see page 27
- Information on other accessories see page 25 - 26

Additional Equipment for Bale-Out Furnaces TB ../12

- Crucible breakage monitoring with optical and acoustic signal
- SMS-alarm message to one or more mobile phones, e.g. in case of crucible breakage
- Equipped with recuperator technology see page 16
- Bath control system see page 28
 - Furnace control via the bath temperature
 - Thermocouples in the furnace chamber and the melt
 - Improved melt quality ensured by a reduction in temperature overshoots
 - Integrated safety controller system that, in case of bath thermocouple breakage, continues to operate the furnace at a reduced output to prevent the melt from solidifying



Bale-out furnace TB 20/14 for bronze melting with side exhaust gas discharge and swiveling collar plate for crucible pulling



Bale-out furnace TB 20/14 in a pit with exhaust gas discharge over the crucible rime and swiveling collar plate for crucible pulling

Model	Tmax furnace °C	Tmax melt bath °C	Crucible	Capacity		Burner output kW	Melting performance ³		Consumption melting kWh/kg	Consumption Holding kWh/h	Outer dimensions ⁴ in mm			Weight in kg
				kg Al	kg Cu		kg/h Al	kg/h Cu			W	D	H	
									Al	Lid closed				
TB 80/12	1200	1050	BU 200	200	650	180	140 ¹	-	1.3 - 1.5	10	1200	1870	1240	900
TB 100/12	1200	1050	BU 250	250	830	180	140 ¹	-	1.3 - 1.5	11	1310	1980	1380	1000
TB 110/12	1200	1050	BU 300	300	1000	210	150 ¹	-	1.3 - 1.5	13	1310	1980	1510	1200
TB 150/12	1200	1050	BU 350	350	1150	300	220 ¹	-	1.3 - 1.5	15	1310	1980	1550	1400
TB 180/12	1200	1050	BU 500	500	1650	300	270 ¹	-	1.3 - 1.5	17	1450	2140	1560	1700
TB 240/12	1200	1050	BU 600	600	2000	390	330 ¹	-	1.3 - 1.5	19	1490	2180	1700	1900
TB 360/12	1200	1050	BN 800	800	-	400	350 ¹	-	1.3 - 1.5	20	1590	2280	1800	2000
TB 400/12	1200	1050	BN 900	900	-	400	350 ¹	-	1.3 - 1.5	22	1590	2280	1900	2100
TB 500/12	1200	1050	BU 1210	1200	-	400	350 ¹	-	1.3 - 1.5	23	1690	2380	1850	2300
TB 600/12	1200	1050	BU 1310	1300	-	500	420 ¹	-	1.3 - 1.5	25	1690	2380	2000	2400
TB 650/12	1200	1050	BP 1000	1400	-	500	420 ¹	-	1.3 - 1.5	26	1760	2450	1630	2300
TB 700/12	1200	1050	BU 1510	1500	-	500	420 ¹	-	1.3 - 1.5	28	1690	2380	2120	2600
TB 800/12	1200	1050	BU 1800	1800	-	500	440 ¹	-	1.3 - 1.5	30	1760	2450	2100	2800
									Cu	Without lid				
TB 10/14	1400	1250	A 100	30	100	210	-	90 ²	1.0 - 1.3	16	980	1590	1190	1000
TB 20/14	1400	1250	A 150	45	150	210	-	100 ²	1.0 - 1.3	17	1080	1870	1310	1250
TB 40/14	1400	1250	A 400	120	400	300	-	300 ²	1.0 - 1.3	23	1210	2000	1460	1500
TB 60/14	1400	1250	A 500	150	500	320	-	320 ²	1.0 - 1.3	26	1210	2000	1510	1600
TB 80/14	1400	1250	A 600	180	600	320	-	320 ²	1.0 - 1.3	29	1260	2050	1540	1750

¹At 700 °C

²At 1000 °C

³The stated melting performances are maximum values. Daily operation comes up to roughly 80 %.

⁴External dimensions vary when furnace is equipped with additional equipment. Dimensions on request.

Bale-Out Furnaces TBR with Recuperative Burner Gas-Fired, for Melting and Holding



Crucible furnace TBR 110/11



Heat exchanger in the exhaust gas duct

The fuel-heated crucible furnaces in the TBR product line fitted with the side exhaust gas discharge provide for optimum energy utilization combined with highest quality melt. Fitted with a burner system including heat-recovery system using a recuperative burner, the energy efficiency of ordinary fuel-heated melting furnaces is significantly improved.

Depending on utilization the hot exhaust gases from the crucible furnace are guided through a heat exchanger in order to preheat the combustion air for the burner. The system provides for energy savings of up to 25 % compared to ordinary fuel-heated furnaces with side exhaust gas discharge. The higher purchase costs are amortized within a short time.

- Tmax 1100 °C for aluminum and zinc alloys
- Two-stage output control: High load for melting operation, low load for holding operation with automatic switching between both modes
- Modern burner system with optimized flame guide: High efficiency provided by over-pressure operation to keep out entrained air
- Heat exchanger in the exhaust gas duct to preheat the combustion air for the burners
- Energy savings of up to 25 % in comparison to other fuel-heated melting furnaces featuring side-wall exhaust gas vents
- Gas system consisting of pressure regulator, gas filter, manometer and solenoid valves



- Safe flame monitoring
- Burner technology with easy-to-service design, compliant with DIN 746, Part 2
- Designed for natural gas or liquid natural gas with 8.8 kWh/m³ - 25.9 kWh/m³
- Required min. gas pressure with full load: 70 mbar
- Operation with other fuels and/or with another gas input pressure possible
- High melting performance powered by high-performance burners and high-quality insulation
- Multi-layered insulation with lightweight refractory bricks provide the furnace chamber lining

2 crucible furnaces TBR 100/11 in production



Production with 16 crucible furnaces TBR 100/11 and 2 crucible furnaces TBR 180/11

- Emergency outlet for safe discharge of the melt in case of a crucible break
- Only fiber materials are used which are not classified as carcinogenic according to TRGS 905, class 1 or 2
- Side exhaust gas discharge
 - Low burn-off provides for high quality melt
 - Low hydrogen absorption by the melt
 - Low heat exposure for the operator in the area above the crucible
- Over-temperature limiter for the furnace chamber with automatic reset to protect against over-temperature. The limit controller switches off the heating when the pre-set limit temperature has been reached and does not switch it on again until the temperature falls below the setting again.
- Furnace chamber control with temperature measurement behind the crucible
- Information about temperature control see page 27 - 29
- Defined application within the constraints of the operating instructions

Additional equipment

- Crucible made of clay graphite or SiC with higher heat conductivity
- Information about exhaust venting see page 6 - 7
- Collecting pan under the emergency outlet see page 26
- Work platform or platform for easier charging
- Crucible break monitoring with optical and acoustic signal
- SMS-alarm message to one or more mobile phones, e.g. in case of crucible breakage
- Bath control system
 - Furnace control via the bath temperature
 - Thermocouples in the furnace chamber and the melt
 - Improved melt quality ensured by a reduction in temperature overshoots
 - Integrated safety controller system that, in case of bath thermocouple breakage, continues to operate the furnace at a reduced output to prevent the melt from solidifying
- Process control and documentation via Nabertherm Control Center (NCC) for monitoring, documentation and control see page 27
- Information on other accessories see page 25 - 26

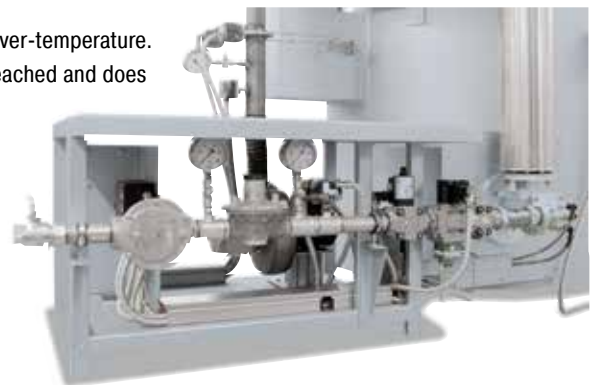

Burner with gas supply system

Model	Tmax furnace	Tmax melt bath	Crucible	Capacity		Burner output	Melting performance ²		Consumption Melting	Consumption holding lid closed
	°C	°C		kg Al	kg Cu		kg/h Al	kg/h Cu		
TBR 80/11	1100	950	BU 200	200	650	180	140 ¹	-	1.0 - 1.1	8.0
TBR 100/11	1100	950	BU 250	250	830	180	140 ¹	-	1.0 - 1.1	8.8
TBR 110/11	1100	950	BU 300	300	1000	210	150 ¹	-	1.0 - 1.1	10.4
TBR 150/11	1100	950	BU 350	350	1150	240	220 ¹	-	1.0 - 1.1	12.0
TBR 180/11	1100	950	BU 500	500	1650	300	270 ¹	-	1.0 - 1.1	13.6
TBR 240/11	1100	950	BU 600	600	2000	320	330 ¹	-	1.0 - 1.1	15.2
TBR 360/11	1100	950	BU 800	800	-	320	350 ¹	-	1.0 - 1.1	16.0

¹At 700 °C

²The stated melting performances are maximum values. Daily operation comes up to roughly 80 %.

Bale-Out Furnaces T

Electrically Heated, for Melting and Holding



Bale-out furnace T 110/11



Four side heating for excellent temperature uniformity



Manual ladling from a bale-out furnace T 80/10

Bale-out furnace T 800/11



Due to their high-grade insulation and optimized connected loads the bale-out furnaces can be used both for melting and holding. They feature good melting performance together with outstanding temperature uniformity in the melt. The 1100 °C version can be used for melting aluminum, the 1200 °C version for brass as well. The 1300 °C version can also be used for melting bronze alloys. The bale-out furnaces are fitted with multi-layer insulation.

- T ../11 with Tmax of 1100 °C for aluminum or zinc, with a maximum melt bath temperature, depending on the condition of the crucible, of 950 °C
- T ../12 with Tmax of 1200 °C also suitable for brass, with a maximum melt bath temperature, depending on the condition of the crucible, of 1050 °C
- T ../13 with Tmax of 1300 °C, also suitable for bronze alloys, with a maximum melt bath temperature, depending on the condition of the crucible, of 1150 °C
- Four-side heating using electric heating elements, freely radiating on support tubes
- Simple replacement of individual heating elements. In case of crucible breakage, only the defective heating elements on each level need to be replaced
- Heating of furnaces up to 60 kW power rating controlled using long-lasting, noiseless solid-state-relays
- Heating of furnaces beyond 60 kW with contactors
- High melting performance with temperature uniformity in the melt
- Insulation constructed in multiple layers with lightweight refractory bricks on the hot face
- Emergency outlet for safe draining of the melt in case of crucible breakage
- Only fiber materials are used which are not classified as carcinogenic according to TRGS 905, class 1 or 2
- No exhaust gas discharge needed
- Integrated safety system which continues to operate the furnace at reduced power in case of malfunction in the bath thermocouple, in order to prevent the freezing of the melt
- Over-temperature limiter in furnace chamber for protection against overheating. The limiter switches the heating off when the set limit temperature is reached, and only switches it back on after the temperature has fallen again
- Furnace chamber control with temperature measurement behind the crucible, recommended for melting
- Crucible not included in the standard version
- For Information on temperature regulation see pages 27 - 29
- Defined application within the constraints of the operating instructions

Additional equipment

- Crucible of clay-graphite or SiC
- Work platform
- Collecting pan under the emergency outlet see page 26
- Crucible breakage monitor with visual and audible signal (not for 1300 °C models)
- SMS-alarm message to one or more mobile phones, e.g. in case of crucible breakage



- Bath control with thermocouples in the furnace chamber and in the melt (not for 1300 °C models). The furnace temperature is controlled through the melt. Temperature overshoots are reduced, thus the quality of the melt is improved
- Heating system operated through thyristors in phase-angle mode assures an even charging of heating elements
- Multi-step switching of the furnace heat (see page 27). In holding mode, a switch or the controller is used to turn off one heating section in order to reduce the electrical rating
- Higher electrical ratings to increase melting performance
- Process control and documentation via Nabertherm Control Center (NCC) for monitoring, documentation and control see page 27
- For information on other accessories see page 25 - 26

Bale-out furnace T 80/13 for gunmetal in a sand foundry shop



Emergency outlet for the safe draining of melt in case of crucible breakage

Model	Tmax furnace	Tmax melt bath	Crucible	Capacity		Heating power in kW ⁴	Melting performance ³		Consumption Holding Lid closed/open kWh/h	Outer dimensions ⁵ in mm			Weight in kg
	°C	°C		kg Al	kg Cu		kg/h Al	kg/h Cu		W	D	H	
T 10/11	1100	950	A 70	20	-	16	32 ¹	-	3/5 ¹	860	860	790	400
T 20/11	1100	950	A 150	45	-	20	42 ¹	-	3/6 ¹	940	940	790	460
T 40/11	1100	950	A 300	90	-	26	58 ¹	-	3/7 ¹	1010	1010	880	580
T 80/11	1100	950	BU 200	200	-	50	126 ¹	-	4/9 ¹	1110	1110	940	650
T 110/11	1100	950	BU 300	300	-	60	136 ¹	-	5/10 ¹	1200	1200	1040	880
T 150/11	1100	950	BU 350	350	-	60	147 ¹	-	5/10 ¹	1200	1200	1250	900
T 180/11	1100	950	BU 500	500	-	70	168 ¹	-	7/15 ¹	1370	1370	1250	1080
T 240/11	1100	950	BU 600	600	-	80	180 ¹	-	7/15 ¹	1370	1370	1350	1200
T 360/11	1100	950	BN 800	800	-	110	200 ¹	-	8/17 ¹	1510	1510	1490	2000
T 400/11	1100	950	BN 900	900	-	110	200 ¹	-	10/20 ¹	1510	1510	1590	2100
T 500/11	1100	950	BN 1200	1200	-	110	200 ¹	-	11/21 ¹	1510	1510	1640	2450
T 600/11	1100	950	BU 1310	1300	-	110	200 ¹	-	13/23 ¹	1615	1615	1730	2550
T 650/11	1100	950	BP 1000	1400	-	110	240 ¹	-	13/20 ¹	1685	1685	1360	2400
T 700/11	1100	950	BU 1510	1500	-	140	240 ¹	-	13/23 ¹	1615	1615	1850	2750
T 800/11	1100	950	BU 1800	1800	-	140	240 ¹	-	15/25 ¹	1685	1685	1830	2800
T 10/12	1200	1050	A 70	20	70	16	32 ¹	47 ²	5/8 ²	860	860	770	440
T 20/12	1200	1050	A 150	45	150	20	42 ¹	63 ²	5/10 ²	940	940	770	520
T 40/12	1200	1050	A 300	90	300	26	58 ¹	84 ²	5/12 ²	1010	1010	860	600
T 80/12	1200	1050	BU 200	200	650	50	126 ¹	190 ²	5/15 ²	1110	1110	930	760
T 10/13	1300	1150	A 70	20	70	16	32 ¹	47 ²	5/8 ²	900	900	890	600
T 20/13	1300	1150	A 150	45	150	20	42 ¹	63 ²	5/10 ²	980	980	890	640
T 40/13	1300	1150	A 300	90	300	26	58 ¹	84 ²	5/12 ²	1050	1050	970	760
T 80/13	1300	1150	BU 200	200	650	50	126 ¹	190 ²	5/15 ²	1150	1150	1030	960

¹At 700 °C

²At 1000 °C

⁵External dimensions vary when furnace is equipped with additional equipment. Dimensions on request.

³The specified melting performances are maximum values. In practice, approx. 80 % are achieved.

⁴Depending on furnace design connected load might be higher

Tilting Furnace KC and Bale-Out Furnace TC SiC-Rod-Heated, for Melting



Tilting furnace KC 180/14



Bale-out furnace TC 80/14



Heated on both sides by high performance SiC rods

The electrically heated tilting furnaces and bale-out furnaces of the KC and TC product lines are characterized by a higher melting performance than achievable with wire heated melting furnaces. These furnaces are designed for permanent operation at working temperatures.

- Tmax 1450 °C also suitable for bronze alloys, with a maximum melting of 1320 °C, depending on the crucible condition
- Heating from two sides by generously dimensioned SiC rods, temperature uniformity
- Simple exchange of individual heating elements
- Heat operation by thyristors in phase-angle mode with performance control:
The resistance of the SiC rods changes with temperature and age. Performance control ensures constant power of heating irrespective to the condition of the heating elements.
- High melting performance with temperature uniformity
- Insulation constructed in multiple layers with lightweight refractory bricks on the hot face
- SiC-Crucible
- Electro-hydraulic tilting system with flame resistant HFC hydraulic fluid (KC models)
- Safe, even, and precise pouring thanks to optimum pivot point in the furnace and manual throttling valve operation (KC models)
- Emergency outlet for safe draining of the melt in case of crucible breakage
- Only fiber materials are used which are not classified as carcinogenic according to TRGS 905, class 1 or 2
- No exhaust gas discharge needed
- Over-temperature limiter in furnace chamber for protection against overheating. The limiter switches the heating off when the set limit temperature is reached, and only switches it back on after the temperature has fallen again
- Furnace chamber control with temperature measurement behind the crucible



Swing lid with good sealing to collar plate to avoid heat loss over the crucible opening



Tilting furnace KC 150/14



Switchgear with thyristors in phase angle operation for economic power consumption

- For Information on temperature regulation see page 27 - 29
- Defined application within the constraints of the operating instructions

Additional equipment

- Work platform for simplified loading
- Process control and documentation via Nabertherm Control Center (NCC) for monitoring, documentation and control see page 27
- For information on other accessories see page 25 - 26



Tilting furnace KC 80/14 during casting

Model	Tmax furnace °C	Tmax melt bath °C	Crucible	Capacity		Heating power in kW ⁴	Connected load in kW	Melting performance ³		Outer dimensions ⁵ in mm			Weight in kg
				kg Al	kg Cu			kg/h Al	kg/h Cu	W	D	H	
KC 20/14	1450	1320	A 150	45	150	36	69	-	120 ²	1710	1900	1050	1500
KC 40/14	1450	1320	A 300	90	300	36	69	-	120 ²	1770	1900	1100	1600
KC 80/14	1450	1320	TPC 287	200	650	48	94	-	180 ²	1880	1970	1160	1900
KC 150/14	1450	1320	TPC 412	300	1000	66	112	-	220 ²	2000	2070	1300	2700
KC 180/14	1450	1320	TPC 412H	-	1150	99	187	-	230 ²	2000	2070	1500	3000
TC 20/14	1450	1320	A 150	45	150	36	69	80 ¹	120 ²	1200	1250	930	830
TC 40/14	1450	1320	A 300	90	300	36	69	80 ¹	120 ²	1260	1250	1020	950
TC 80/14	1450	1320	BU 200	200	650	48	94	120 ¹	180 ²	1360	1350	1080	1050
TC 150/14	1450	1320	BU 300	300	1000	66	112	140 ¹	220 ²	1450	1320	1300	1300

¹At 700 °C

²At 1000 °C

³The specified melting performances are maximum values. In practice, approx. 80 % are achieved.

⁴Depending on furnace design connected load might be higher

⁵External dimensions vary when furnace is equipped with additional equipment. Dimensions on request.

Bale-Out Furnaces T ../10 Electrically Heated, for Holding



Bale-out furnace T 150/10

The perfect insulation and the reduced electric connected loads provide for perfect energy efficiency and make the bale-out furnaces T ../10 optimally suitable for holding operation. Due to the reduced connected load these bale-out furnaces are only suitable for melting to a limited extent. This is why they are mostly used in foundries with central pre-melting furnaces followed by transportation of the melt to the holding furnace.

- Tmax 1000 °C, ideally suited for the holding of aluminum
- Four-side heating using electric heating elements, freely radiating on support tubes
- Simple replacement of individual heating elements. In case of crucible breakage, only the defective heating elements on each level need to be replaced
- Heating of furnaces up to 60 kW power rating controlled using long-lasting, noiseless solid-state-relays
- Heating of furnaces beyond 60 kW with contactors
- Particularly good insulation constructed in multiple layers with lightweight refractory bricks on the hot face



Bale-out of T 650/10 with robot

- Emergency outlet for safe draining of the melt in case of crucible breakage
- Only fiber materials are used which are not classified as carcinogenic according to TRGS 905, class 1 or 2
- No exhaust gas discharge needed
- Crucible not included in the standard version
- Integrated safety system which continues to operate the furnace at reduced power in case of malfunction in the bath thermocouple, in order to prevent the freezing of the melt
- Over-temperature limiter in furnace chamber for protection against overheating. The limiter switches the heating off when the set limit temperature is reached, and only switches it back on after the temperature has fallen again.
- Furnace chamber control with temperature measurement behind the crucible, recommended for melting
- For Information on temperature regulation see page 27 - 29
- Defined application within the constraints of the operating instructions

Additional equipment, see T furnaces, page 18

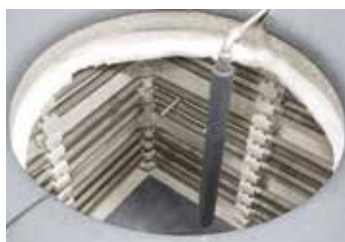

Design of a holding furnace with bath control system containing thermocouples for the melt, the furnace chamber and the over-temperature limiter

Model	Tmax furnace °C	Tmax melt bath °C	Crucible	Capacity		Heating power in kW ²	Consumption Holding Lid closed/open kWh/h	Outer dimensions ³ in mm			Weight in kg
				kg Al	kg Cu			W	D	H	
T 80/10	1000	800	BU 200	200	-	20	4/9 ¹	1150	1150	1030	660
T 110/10	1000	800	BU 300	300	-	26	5/10 ¹	1240	1240	1130	890
T 150/10	1000	800	BU 350	350	-	38	5/10 ¹	1240	1240	1290	920
T 180/10	1000	800	BU 500	500	-	42	7/15 ¹	1410	1410	1290	1120
T 240/10	1000	800	BU 600	600	-	50	7/15 ¹	1410	1410	1390	1240
T 360/10	1000	800	BN 800	800	-	50	8/17 ¹	1510	1510	1490	2000
T 400/10	1000	800	BN 900	900	-	50	10/20 ¹	1510	1510	1590	2100
T 500/10	1000	800	BU 1210	1200	-	50	11/21 ¹	1615	1615	1580	2450
T 600/10	1000	800	BU 1310	1300	-	50	13/23 ¹	1615	1615	1730	2550
T 650/10	1000	800	BP 1000	1400	-	60	13/20 ¹	1685	1685	1360	2400
T 700/10	1000	800	BU 1510	1500	-	60	13/23 ¹	1615	1615	1850	2750
T 800/10	1000	800	BU 1800	1800	-	70	15/25 ¹	1685	1685	1830	2800

¹At 700 °C

³External dimensions vary when furnace is equipped with additional equipment. Dimensions on request.

²Depending on furnace design connected load might be higher

Transportable Bale-Out Furnaces TM Electrically Heated, for Holding Aluminum

The bale-out furnaces of the TM product lines were developed especially for use at different pouring locations. The cylindrical, very stable furnace housing, the very high-quality insulation and the meandering heating elements are the special features of this furnace family. The furnaces are designed to be transported by forklift truck and come with a plug-in connection to the control gear. With a forklift truck the furnace can be transported to the pre-melt furnace for filling. When additional switchgear and control boxes are used, the bale-out furnace can also be optionally used at different pouring locations.



Transportable holding furnace
TM 80/10

- Tmax 1000 °C, ideal for holding of aluminum
- Cylindrical, highly stable furnace housing
- Damper slots under the furnace for safe forklift transportation of the furnace inside the foundry
- All-round heating provided by resistant meandering heating elements
- Switchgear and control box for plug-in connection
- Heating of furnaces up to 60 kW power rating controlled using long-lasting, noiseless solid-state-relays
- Insulation constructed in multiple layers with lightweight refractory bricks on the hot face
- Emergency outlet for safe discharge of the melt in case of a crucible break
- Only fiber materials are used which are not classified as carcinogenic according to TRGS 905, class 1 or 2
- No exhaust gas vent necessary
- Crucible in standard design not included
- Furnace chamber control with temperature measurement behind the crucible
- Over-temperature limiter in the furnace chamber to protect against over-temperature. The limit controller switches off the heating when the pre-set limit temperature setting has been reached and does not switch it on again until the temperature falls below the setting again.
- For Information on temperature regulation see page 27 - 29
- Defined application within the constraints of the operating instructions

Additional equipment, see T furnaces, page 18



Slots under the furnace for the forklift forks



Forklift entry with dampers



Meander heating elements

Model	Tmax furnace °C	Tmax melt bath °C	Crucible		Capacity		Heating power in kW ²	Consumption Holding Lid closed/open kWh/h ¹	Outer dimensions ³ in mm		
			Ø	H	kg Al	kg Cu			W	D	H
TM 80/10	1000	800	BU 200		200	-	21	4/9	1000	1100	1150
TM 150/10	1000	800	875	600	350	-	36	5/10	1320	1440	1150
TM 240/10	1000	800	BU 600		600	-	42	7/15	1220	1340	1450
TM 310/10	1000	800	1170	580	770	-	42	8/17	1650	1730	1200

¹At 700 °C

³External dimensions vary when furnace is equipped with additional equipment. Dimensions on request.

²Depending on furnace design connected load might be higher



Plug socket on the furnace for the cable connection to the switchgear and control box

Bath Furnaces B

Electrically Heated, for Holding of Aluminum



Bath furnace B 500



Bath furnace B 120



Inlet opening for filling with liquid aluminum



Melting thermocouple in the bath of the outlet opening



Heating mounted in the lid, simple replacement of the heating elements

The B 120 - B 500 bath furnaces (without crucibles) have been especially developed for stationary holding operation in die-cast foundries with removal of the melt by a bale-out robot. The tub of the bath furnaces is lined with special long-life brick. The multi-layered backing insulation is designed for lowest electric connected load. The furnace tub is divided into three interconnected chambers. The heating proceeds from the lid into the center chamber. The bale-out openings are dimensioned to enable the robot to be optimally used. In holding operation bath furnaces, when used properly, provide better energy efficiency than bale-out furnaces.

- Tmax 1000 °C, perfectly suited for holding of aluminum at about 720 °C
- Heating mounted in the lid, freely radiating from carrier tubes
- Particularly low energy consumption due to generously dimensioned, multi-layer insulation
- Only fiber materials are used which are not classified as carcinogenic according to TRGS 905, class 1 or 2
- High melt quality due to very low corundum formation on the surface
- Heating switched by solid-state-relays
- No exhaust gas discharge needed
- Temperature control with measurement in the melt and in the furnace chamber
- Plug for connection with separate switchgear cabinet
- For information on temperature control see page 27 - 29
- Useful only for holding, not for melting
- Defined application within the constraints of the operating instructions

Additional Equipment

- Adaptation to dosing pump
- Automated lid opening for ladling operation
- Ladle opening adapted to size of ladle

Model	Tmax furnace °C	Tmax melt bath °C	Capacity kg Al	Heating power in kW ¹	Consumption Holding kW h/h	Bale-out opening mm	Outer dimensions ² in mm			Weight in kg
							W	D	H	
B 120	1000	750	300	11	2	300 x 300	1900	1150	1160	1900
B 250	1000	750	600	14	3	380 x 380	2030	1280	1200	2450
B 500	1000	750	1200	20	5	430 x 430	2350	1450	1240	3700

¹Depending on furnace design connected load might be higher

²External dimensions vary when furnace is equipped with additional equipment. Dimensions on request.

Accessories for Bale-Out and Tilting Furnaces

Crucible Pulling Feature with Swinging Collar Plate

In standard version, Nabertherm crucible furnaces are built with a collar plate fixed to the furnace. The bale-out is done manually or by robot. As additional equipment, the smaller models up to T 40 can be equipped with a swinging collar plate which allows crucible pulling. To pull the crucible, the collar plate is swung to the side, so that the operator has free access to the crucible from above.



Crucible Pulling Feature with swinging collar plate

Pneumatic Lid Opener for Bale-Out Furnaces for Holding

The crucible furnaces of the T.. product lines can be equipped with an optional pneumatic lid opener. The pneumatic lid opener is activated by depressing a foot pedal. Optionally, the pneumatic lid opener can be controlled and triggered by an external signal to fully automate the ladling process. The furnace lid swings to the side and the operator has free access to the crucible. This practical feature increases energy efficiency because the furnace is only open during charging and bale-out. Over 50 % energy savings can be realized with the pneumatic lid opener vs. an always open furnace (see tables for energy consumption for each model of melting furnace, page 7).



Pneumatic lid opener

Charging Funnel for Ingots

The charging funnel made of stainless steel 1.4301 (304) makes charging the furnace much easier, especially when melting ingots. Long ingots can also be charged extending over the crucible edge, and then sink, guided, into the crucible. Furnaces which are designed with a control system with night-time reduction can, for example, be filled in the evening and, on the following morning a complete melt is ready for use. The funnel is suitable for all melting furnaces, electrically heated or gas- with a side exhaust gas discharge.



Charging funnel for ingots

Work Platform for Loading for Bale-Out and Tilting Furnaces

For bale-out and tilting furnaces, customized work platforms for charging and servicing can be provided as additional equipment. This feature is used to simplify access to the furnace, particularly for larger furnace models. The operator has access to the top of the furnace to charge ingots or clean the melt.



Work platform for K 240/12

Accessories for Bale-Out and Tilting Furnaces



Crucible breakage alarm device under the emergency outlet of a melting furnace

Crucible Breakage Alarm Device (up to T(B)..-/12)

Nabertherm melting furnaces are equipped with emergency outlet. In case of crucible breakage or leaking melt the crucible breakage alarm device will provide for a warning as soon as fluid metal emerges from the emergency outlet. The warning signal of the alarm is both optical, with an signal lamp, and acoustic, using a horn. As additional equipment it is possible to send an alarm as SMS-message to one or more mobile phones. One or more furnaces can be connected to the messaging device in parallel.



Collecting pan under the emergency outlet

Collecting Pan under the Emergency Outlet

The bale-out furnaces are standardly equipped with an inclined bottom and an emergency outlet for liquid metal in case of a crucible breakage. To collect the liquid melt in case of an emergency the models T..., TB..., K... and KB... can be delivered with a small base frame and a collecting pan. The pan can safely receive full crucible volume and is equipped with a pull-out handle. Unnecessary foundation works can be avoided.

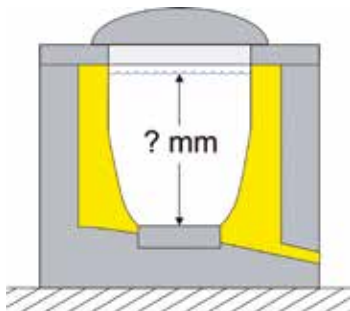

Filling Level Measurement by means of Optical Detection or Weight Loss

When crucible furnaces are used in continuous operation, it can be necessary to monitor the filling level of the crucible and provide for a signal when defined levels are reached. The signal can be either optical, acoustic, or a signal for automatic filling of the crucible. When the minimum level is reached, a signal to fill a crucible is given. On reaching the maximum level this process is stopped. The measurement of fill level can either be done by using a scale under the furnace or by using a measurement probe to detect the fill level and which records the data very precisely independent from external influences.

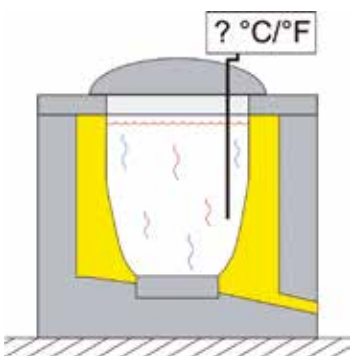

Separate Bath Temperature Measurement Device

For melting furnaces with only furnace chamber temperature control, a separate bath temperature measurement device can be used to check the bath temperature. The measurement device is suitable for a temperature range from 0 °C to 1300 °C, and can be delivered with different dip pipe lengths (200 mm, 380 mm, 610 mm). Temperature measurement is carried out using a NiCr-Ni thermocouple. The submersion length of the pipe should be 2/3 of the element length to achieve the most ideal reaction time. The average reaction time is 40 seconds. The thermocouple is suitable for all nonferrous metals except phosphor bronze.

Control and Documentation Alternatives for Melting Furnaces

Band Alarm under/over Temperature

A band alarm displays the working range for casting. If the temperature is within the range, a green signal lamp is lit and the melt can be processed. In this range, the controller additionally provides for a signal that the customer can evaluate. Example: Release for the foundry robot.

Manual Program Intervention

If the current program is to be prolonged and the controller should not go to the next segment (e.g. continuation of melting operation in case of overtime), a key switch can be used to change over from program operation to controller operation. The controller continues working with the previously set temperature until the switch is activated again in order to continue with the program.

Documentation with NTLog

For process documentation, the H500-controls can be equipped with NTLog. For detailed description see page 28 - 29.

Documentation with NCC

The H700-controls can be supplemented with the Nabertherm Control Center Software (NCC) including PC. The NCC-controls provide for a convenient documentation of the melting operation with the following documentation options:

- All relevant data, such as furnace temperature, melt bath temperature, messages, etc. are always saved as a file each day
- The furnace is equipped with an additional start and stop button in a separate housing. When the button is pressed, the melt bath temperature is recorded separately and saved as a file. This enables customer charges to be analyzed and archived separately.
- The PC can also be used as a user interface with all the benefits of a computer
- NCC AA (Aviation and Automotive) for applications according to CQI9, AMS or NADCAP



User interface Control Center NCC based on PC

Additional Equipment for All Electrically Heated Melting Furnaces

Multi-Step Switch for Reduction of Connected Rating

A multi-step switch switches off a part of the heating depending on the power of the corresponding furnace model. Generally, the furnace can be operated at full load for melting. If the furnace is only used in holding mode the connected rating of the furnace can be reduced by turning off a defined part of the heating capacity, resulting in a significant cost advantage. As an option, this function can be automatically switched depending on temperature.

Power Management for Reduction of the Electrical Connection Value

If several crucible furnaces are used the installation of an intelligent power management can be the right choice. Monitoring all furnaces the power management is continuously reconciling the switch-on times of the heating. This effectively prevents all furnaces from switching-on at the same time. The positive impact is that the total connected rating provided by the energy provider can be significantly reduced.



Multi-Step Switch

Switchgear Cooling with Fans or Air-Conditioning

The switchgear of our furnaces is designed for environment temperatures of up to 40 °C. To secure a failure-free and long lasting operation of the switchgear in case of higher temperatures they can be equipped with active fan cooling or even with an air-conditioner.

Control and Documentation Alternatives for Melting Furnaces



Eurotherm 3208 furnace controller

Furnace Control with Eurotherm 3208 or 3508 and Optional Weekly Timer

In the basic design, Nabertherm melting furnaces are equipped with Eurotherm 3208 or 3508 controllers. The temperature is measured inside the furnace behind the crucible. Two setpoints and one heating ramp can be set. For example, the setpoints could be the working temperature and the lower temperature for night setback. A digital weekly timer can also be used as an accessory which automatically switches between the two temperatures and the on/off function of the furnace. The switching times can be chosen for each working day.



Weekly timer to switch between melting temperature and lower temperature

Melt Bath Control (cascade control) via PLC and H500 or H700 Touch Panel for BaleOut and Tilting Furnaces

In the basic design, the baleout and tilting furnaces are controlled with a thermocouple inside the furnace chamber behind the crucible. For fast heat-up times, the operator usually sets a temperature that is higher than the desired melt bath temperature. This control enables fast heating times but also results in temperature overshoots in the melt due to the indirect temperature measurement.

As in option the baleout and tilting furnaces can be equipped with a melt bath control. In addition to the furnace thermocouple, the temperature is also measured with a thermocouple in the melt. Both temperatures are permanently reconciled to achieve the exact melt bath temperature. If the melt bath thermocouple fails, the system automatically switches over to furnace control. This control considerably improves the quality of the melt because overshoots are effectively prevented. This type of temperature control is especially recommended for holding in order to control the melt bath temperature as precisely as possible. It is also the best choice for a quick and automatic melting process without any need for the operator to intervene in the temperature control during melting.



Melt bath control with a thermocouple in the melt

As an alternative to a thermocouple in the melt, a thermocouple in a pocket inside the crucible wall can also be used (special crucible with pocket required) which measures the temperature of the crucible wall. This indirect measurement is not as precise as measuring directly in the melt and automatic melting is slightly slower. However, the thermocouple is in a more protected position. This simplifies charging of the crucible and increases the thermocouple life time.

Controller Type	Eurotherm 3208		Eurotherm 3508	H500	H700	
	TM/T/K	TB/TBR/KB/KBR	TC/KC	TC/TM/T/K/KC	TM/T/K	TB/TBR/KB/KBR
Available for furnace type						
Functions						
Furnace control	●	●	●	●	●	●
Melt bath control				●	●	●
Weekly timer	○	○	○	●	●	●
Bridging the melt bath controller				○	○	○
Preparation program with 20 segments				●	●	●
Preparation program with a ramp	●	●	●			
Band alarm under/over temperature	○	○	○	●	●	●
Connection to an overriding system	○	○	○	○	○	○
Operation with reduced power	○			○	○	○
Operating hour counter	○	○	○	●	●	●
Documentation with NTLog				○		
Documentation with NCC					○	○
Manual intervention in the program					○	○

● Standard
○ Option

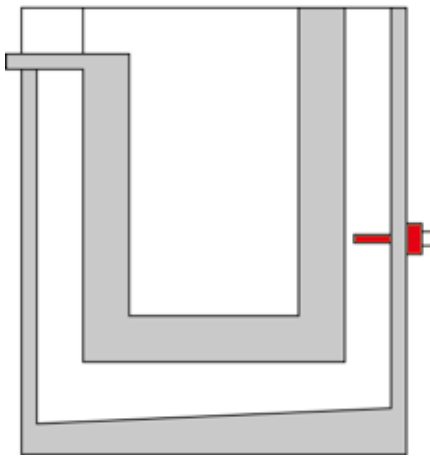

Furnace control

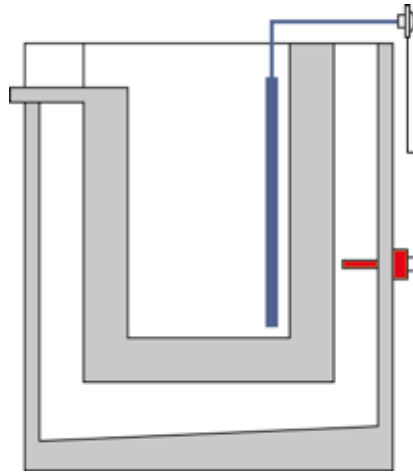

Melt bath control thermocouple in the melt

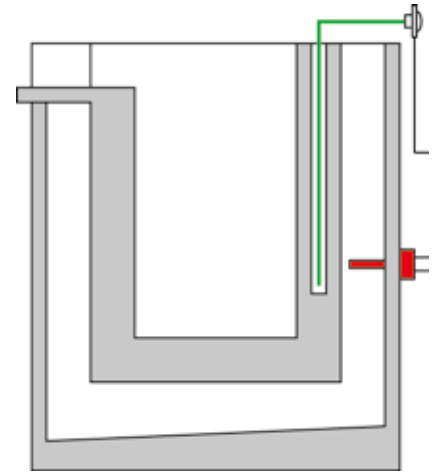

Melt bath control thermocouple in the pocket of the crucible wall

The melt bath is controlled via the H500 PLC-controls (electrically heated furnaces) with a 4 inch (optional 7 inch) touch panel and 4 operating buttons or the H700-controls (gasfired furnaces) with a 7 inch touch panel. It combines simple operation, precise control, and extensive user options. Presentation and program entry are done directly by a very simple to operate touch panel. The functions are displayed in plain text.

- Operation with furnace chamber control or melt bath control alternatively with cascade
- Display on a graphic color screen with overview of all temperatures
- Very easy data entry directly on the operating screen (touch panel)
- Weekly timer for changing temperatures, entries in real time
- A program with 12 segments can be set for each weekday
- Separate, freely programmable preparation program, password protected, e.g. to dry the crucible
- Band alarm with over and/or under temperature monitoring
- Operating hour counter
- Integrated safety system that continues furnace operation at reduced power in case of a fractured melt bath thermocouple to prevent the melt from solidifying
- Trend display of the furnace temperatures in the past 72 hours
- Language choice



H500

Furnaces already in use can be retrofitted with a melt bath controller.

Bridging the Melt Bath Controls to Increase Melting Performance and Reduce Melting Times

If a completely empty crucible is to be refilled, the values measured by the melt bath thermocouple do not correspond to the actual temperature of the cold metals because the charge is not yet melted. A pushbutton is used to temporarily specify a higher furnace temperature than the program would adjust. The operator selects the desired time (max. 120 minutes) and the furnace temperature. When the time has expired, the controller automatically switches back to melt bath control.

Operation with Reduced Power

Operation with reduced power can be used to temporarily reduce the connected load of the furnace when the working temperature is reached. If reduced power is activated and the temperature in the furnace is within or above the set temperature band, part of the heating is switched off to operate the furnace with reduced power.

MO + TU SP 1-4		Monday (Business)		Tuesday (Business)	
Number	Furnace [°C]	Start	End	Start	End
SP1	850	04:30:00	1	00:00:00	0
SP2	730	06:45:00	1	07:00:00	1
SP3	730	10:30:00	1	10:00:00	1
SP4	850	13:00:00	1	12:30:00	1
SP 9-12 <--		--> SP 5-8		Su <-- --> We - Th	
back				clear	

Entry of temperature/time programs in tabular format in several segments

Melting Furnaces in Customized Dimensions

Tilting Furnaces with Electrohydraulic Lifting Platforms

Depending on the material flow and space requirements in a foundry, the charging height and pouring height may need to be different for a tilting furnace. For instance, if loading is performed at ground level and the metal is poured into a machine at a higher level, then an optional electro-hydraulic lifting platform can adjust for the difference. The operation of the lifting platform is by means of a 2 hand operation with a manual throttling valve. It can also be interlocked with other machinery and be motor driven operated.



Tilting furnace K 240/12 with lifting platform for charging and pouring at different levels

Melting Furnaces for Heavy Metals

Our melting furnaces in the K and T product lines can be upgraded with adapted electrical heating for melting of heavy metals like lead and zinc. The melting furnace is equipped with a special crucible, in most cases a steel crucible. The melting power is tailored to the type of metal to ensure optimum utilization of the melting furnace.



Tilting furnace K 240/11 for melting of lead



Steel crucible with special suspension brackets for high charge weight

Rotary Table System for Continuous Pouring

For continuous processes, multiple crucible furnaces can be combined on a rotary table system. For example, when using three furnaces with a rotation in 120° steps, loading takes place at the first space, de-gassing at the second space, and bale-out at the third. This ensures a continuous supply of liquid metal at the pouring location. The rotary table is designed with an emergency drain below in case of crucible breakage.



Rotary table system with 3 x T 150/11

Magnesium Melting Furnaces

For a variety of projects, Nabertherm has supplied melting furnaces to be upgraded by the customer for the melting of magnesium. Nabertherm supplied the furnace with all necessary control systems and the steel crucible. The furnaces were completed by the customer with the safety devices, pump systems for bale-out, and gas supply systems. We are capable of implementing furnace systems to provide for a crucible volume of 1500 liters of magnesium.



Tilting furnaces for magnesium K 1500/75 S with 1500 liters crucible volume

Laboratory Melting Furnaces



Melting furnace K 4/10



Melting furnace KC 2/15

These compact melting furnaces for the melting of non-ferrous metals and alloys are one of a kind and have a number of technical advantages. Designed as tabletop models, they can be used for many laboratory applications. The practical counter balanced hinge with shock absorbers and the spout (not for KC) on the front of the furnace make exact dosing easy when pouring the melt. The melting furnaces are available for furnace chamber temperatures of 1000, 1300, or 1500 °C. This corresponds to melt temperatures of about 80 °C - 110 °C lower.

- Tmax 1000 °C, 1300 °C, or 1500 °C
- Crucible sizes of 0,75, 1,5 or 3 liters
- Crucible with integrated pouring spout of iso-graphite included with delivery
- Additional spout (not for KC), mounted at the furnace for exact pouring
- Only fiber materials are used which are not classified as carcinogenic according to TRGS 905, class 1 or 2
- Compact bench-top design, simple emptying of crucible by tilting system with gas damper
- Crucible for heating up of melting furnace insulated with a hinged lid, lid opened when pouring
- Defined application within the constraints of the operating instructions
- Controls description see page 78

Additional equipment

- Other crucible types available, e.g. steel
- Design as bale-out furnace without tilting device, e.g. for lead melting
- Over-temperature limiter for the furnace chamber with automatic reset to protect against overtemperature. The limit controller switches off the heating when the pre-set limit temperature has been reached and does not switch it on again until the temperature falls below the setting again.
- Observation hole for melt



Melting furnace KC 2/15

Model	Tmax furnace °C	Tmax melt bath °C	Crucible	Volume in l	Outer dimensions ⁴ in mm			Heating power in kW ³	Weight in kg
					W	D	H		
K 1/10	1000	850	A 6	0.75	520	680	660	3.0	85
K 2/10	1000	850	A10	1.50	520	680	660	3.0	90
K 4/10	1000	850	A25	3.00	570	755	705	3.6	110
K 1/13 ¹	1300	1150	A 6	0.75	520	680	660	3.0	120
K 2/13 ¹	1300	1150	A10	1.50	520	680	660	3.0	125
K 4/13 ¹	1300	1150	A25	3.00	570	755	705	5.5	170
KC 1/15 ²	1500	1320	A6	0.75	580	630	580	10.5	170
KC 2/15 ²	1500	1320	A10	1.50	580	630	580	10.5	170

¹Outer dimensions of furnace, transformer in separate housing (500 x 570 x 300 mm)

²Switchgear and controller mounted in a floor standing cabinet

³Depending on furnace design connected load might be higher

⁴External dimensions vary when furnace is equipped with additional equipment. Dimensions on request.

Cleaning Furnace for Riser Tubes Electrically Heated



SRO 170/1000/11

Riser tubes for low-pressure melting furnaces must be cleaned in regular intervals. To remove deposits the pipe must be removed from the furnace and heated. In comparison to applying an open flame to heat the pipe, the SRO 170/1000/11 furnace offers the advantages of very uniform tube heating. The quality of the heat treatment is clearly better and the life-time of the risers can be extended when cleaned regularly. The heated rising tube can be removed from the furnace hot and returned to the low-pressure melting furnace.

The furnace is charged from above using a crane provided by the customer. Located in the lower section of the furnace is a steel catch drawer which is filled with sand or sizing compound. The rising tube hangs in the receptacle with a crane eye and the deposits drip into the drawer. Designed as a drawer, it can be easily pulled out, emptied and filled again.

- Tmax. 1100 °C
- Charging opening with collar plate and swing lid on the furnace. Charging of the rising tube using the customer crane
- Max. dimensions of the rising tube: L: 1000 mm, outer dimension 90 mm with single-side flange with an outer diameter of 115 mm
- Only fiber materials are used which are not classified as carcinogenic according to TRGS 905, class 1 or 2
- Heated length: 1000 mm
- Charge receptacle with crane eye for holding smaller risers
- Steel catch draw, filled by the customer with sand, which collects deposits
- Steel collector designed as a drawer
- Furnace on rollers
- Switchgear and control equipment fastened directly to the furnace
- Defined application within the constraints of the operating instructions
- NTLog Basic for Nabertherm controller: recording of process data with USB-flash drive
- Controls description see page 78

Additional equipment

- Design for other riser dimensions on request
- Switchgear on rollers
- Process control and documentation via VCD software package or Nabertherm Control Center (NCC) for monitoring, documentation and control see page 78



Furnace SRO 170/1000/11 with suspended pipe



To be pulled with crane eye for riser tubes with flange

Model	Tmax °C	Outer dimensions ² in mm			Outer tube-Ø/ mm	Heated length/mm	Heating power in kW ¹	Electrical connection*
		W	D	H				
SRO 170/1000/11	1100	590	640	1700	90	1000	12,0	3-phase

¹Depending on furnace design connected load might be higher

*Please see page 79 for more information about supply voltage

²External dimensions vary when furnace is equipped with additional equipment. Dimensions on request.

Chamber Ovens

Electrically Heated or Gas-Fired



Chamber oven KTR 1500



Chamber oven KTR 4500



Chamber oven KTR 6125

The chamber ovens of the KTR range can be used for complex drying processes and heat treatment of charges to an application temperature of 260 °C. The high-performance air circulation enables optimum temperature uniformity throughout the work space. A wide range of accessories allow the chamber ovens to be modified to meet specific process requirements. The design for the heat treatment of flammable materials in conformance with EN 1539 (NFPA 86) is available for all sizes.

- Tmax 260 °C
- Electrically heated (via a heating register with integrated chrome steel heating elements) or gas-fired (direct or indirect gas-fired including injection of the hot air into the intake duct)



Chamber oven KTR 1500 with charging cart

- Temperature uniformity up to +/- 3 °C according to DIN 17052-1 (for design without track cutouts) see page 74
- High-quality mineral wool insulation provides for outer temperatures of < 25 °C above room temperature
- Only fiber materials are used which are not classified as carcinogenic according to TRGS 905, class 1 or 2
- High air exchange for fast drying processes
- Double-wing door for furnaces KTR 3100 and larger



Chamber oven KTR 22500/S with chamber lightning and drive-in tracks with insulated plugs which provide for an optimal temperature uniformity

- Over-temperature limiter with adjustable cutout temperature for thermal protection class 2 in accordance with EN 60519-2 as temperature limiter to protect the oven and load
- Incl. floor insulation
- Defined application within the constraints of the operating instructions
- NTLog Basic for Nabertherm controller: recording of process data with USB-flash drive
- Controls description see page 78

Additional equipment

- Track cutouts for level drive-in of charging cart
- Base frame to charge the oven via a charging forklift
- Additional door in the back for charging from both sides or to use the oven as lock between two rooms
- Fan system for faster cooling with manual or motor-driven control of the exhaust flaps
- Programmed opening and closing of exhaust air flaps
- Air circulation with speed control, recommendable for processes with light or sensitive charge
- Observation window and furnace chamber lighting
- Safety technology according to EN 1539 (NFPA 86) (models KTR .. LS) for charges containing solvents see page 55
- Charging cart with or without rack system
- Design for clean room heat treatment processes
- Rotating systems for tempering processes
- Process control and documentation via VCD software package or Nabertherm Control Center (NCC) for monitoring, documentation and control see page 78



KTR 3100/S for curing of composites in vacuum bags incl. pump and necessary connections in the oven chamber



Direct gas-fired at a chamber oven

Chamber Ovens

Electrically Heated or Gas-Fired



Charging cart with pull-out trays



Chamber oven KTR 6250 with double doors in the front and in the back as well as guide-in tracks for use as sluice oven



Drive-in tracks with sealing shoes

Accessories

- Adjustable plate shutters to adapt the air guide to the charge and improve temperature uniformity
- Guide-in tracks and shelves
- Shelves with 2/3 extraction with evenly distributed load on the whole shelf surface
- Platform cart in combination with drive-in tracks
- Charging cart with rack system in combination with drive-in tracks
- Sealing shoes for ovens with drive-in tracks to improve temperature uniformity in the work space

All KTR-models are also available with Tmax 300 °C.



Pull-out shelves, running on rolls

Model	Tmax °C	Inner dimensions in mm			Volume in l	Outer dimensions in mm ²			Heating power in kW ¹ KTR/KTR ..LS	Electrical connection*
		w	d	h		W	D	H		
KTR 1000 (LS)	260	1000	1000	1000	1000	1900	1430	1815	18/on request	3-phase
KTR 1500 (LS)	260	1000	1000	1500	1500	1900	1430	2315	18/36	3-phase
KTR 3100 (LS)	260	1250	1250	2000	3100	2150	1680	2905	27/45	3-phase
KTR 4500 (LS)	260	1500	1500	2000	4500	2400	1930	2905	45/54	3-phase
KTR 6125 (LS)	260	1750	1750	2000	6125	2650	2200	3000	45/63	3-phase
KTR 6250 (LS)	260	1250	2500	2000	6250	2150	3360	3000	54/on request	3-phase
KTR 8000 (LS)	260	2000	2000	2000	8000	2900	2450	3000	54/81	3-phase
KTR 9000 (LS)	260	1500	3000	2000	9000	2400	3870	3000	72/on request	3-phase
KTR 12300 (LS)	260	1750	3500	2000	12300	2650	4400	3000	90/on request	3-phase
KTR 16000 (LS)	260	2000	4000	2000	16000	2900	4900	3000	108/on request	3-phase
KTR 21300 (LS)	260	2650	3550	2300	21300	3750	4300	3500	108/on request	3-phase
KTR22500 (LS)	260	2000	4500	2500	22500	2900	5400	3500	108/on request	3-phase

¹Depending on furnace design connected load might be higher

^{*}Please see page 79 for more information about supply voltage

²External dimensions vary when furnace is equipped with additional equipment. Dimensions on request. Outer dimensions from chamber ovens KTR .. LS are different

Max. amount of silicone per charge at a fresh air amount of 120 l/min/kg_{silicone}

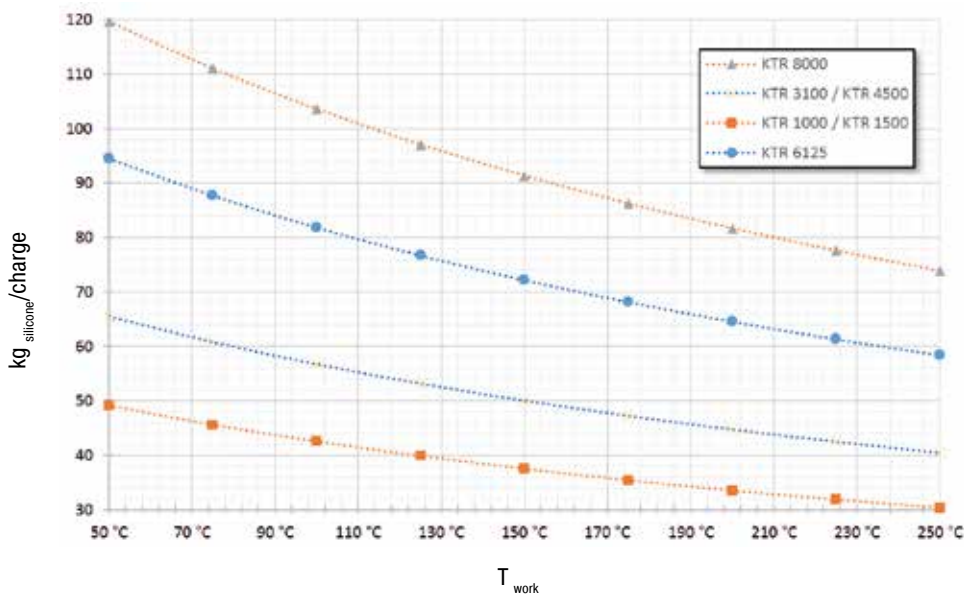

Adjustable plate shutters to adapt the air guide to the charge

To ensure safe operation of the oven when tempering silicone, the fresh air supply of the oven must be monitored. A fresh air volume flow of 100 - 120 l/min/kg silicone (6-7,2 m³/h/kg silicone) has to be considered. The graph shows the maximum amount of silicone depending on the operating temperature for various KTR models at a fresh air supply of 120 l/min/kg silicone. The oven will be carried out in accordance with the requirements of the standard EN 1539 (NFPA 86).



Motor-driven rotary rack with baskets for moving the charge during heat treatment



Chamber oven KTR 3100 DT with rotating system for tempering of silicone parts. Four baskets will be charged in the frame and can be taken out separately



Drive-in ramp

Forced Convection Chamber Furnaces < 675 Liters Electrically Heated



Forced convection chamber furnace
NA 120/45



Forced convection chamber furnace NA 250/45



Forced convection chamber furnace
NA 15/65 as table-top model

The very good temperature uniformity of these chamber furnace with air circulation provides for ideal process conditions for annealing, curing, solution annealing, artificial ageing, preheating, or soft annealing and brazing. The forced convection chamber furnaces are equipped with a suitable annealing box for soft annealing of copper or tempering of titanium, and also for annealing of steel under non-flammable protective or reaction gases. The modular forced convection chamber furnace design allows for adaptation to specific process requirements with appropriate accessories.

- Tmax 450 °C, 650 °C, or 850 °C
- Stainless steel air-baffles in the furnace for optimum air circulation
- Swing door hinged on the right side
- Base frame included in the delivery, NA 15/65 designed as table-top model
- Horizontal air circulation
- Temperature uniformity up to +/- 4 °C according to DIN 17052-1 (model NA 15/65 up to +/- 5 °C) see page 74
- Optimum air distribution enabled by high flow speeds
- One frame sheet and rails for two additional trays included in the scope of delivery (NA 15/65 without frame sheet)
- Only fiber materials are used which are not classified as carcinogenic according to TRGS 905, class 1 or 2
- Defined application within the constraints of the operating instructions
- NTLog Basic for Nabertherm controller: recording of process data with USB-flash drive
- Controls description see page 78



Forced convection chamber furnace
N 250/85HA with quenching bath

- Additional equipment (not for model NA 15/65)
- Optimization of the temperature uniformity up to +/- 3 °C according to DIN 17052-1 see page 74
 - Air inlet and exhaust air flaps when used for drying
 - Controlled cooling with fan
 - Manual lift door (up to model N(A) 120/.. (HA))
 - Pneumatic lift door
 - Air circulation with speed control, recommendable for processes with light or sensitive charge
 - Additional frame sheet
 - Roller conveyor in furnace chamber for heavy charges



Forced convection chamber furnace NA 120/45 with fresh-air cooling

- Annealing boxes
- Feed and charging aids
- Safety technology according to EN 1539 (NFPA 86) (models NA .. LS) for charges containing solvents
- Inlets, measuring frames and thermocouples for TUS measurements charge or comparative measurements
- Charge control
- Process control and documentation via VCD software package or Nabertherm Control Center (NCC) for monitoring, documentation and control see page 78



Forced convection chamber furnace NA 500/45S with four compartments, each with roller conveyor and individual door

Model	Tmax °C	Inner dimensions in mm			Volume in l	Outer dimensions ⁶ in mm			Heating power in kW ³ NA/NA .. LS	Electrical connection*	Weight in kg	Heat-up time ⁵ to Tmax in minutes	Cool-down time ⁵ from Tmax to 150 °C in minutes	
		w	d	h		W	D	H					Flaps ⁴	Fan cooling ⁴
NA 30/45(LS)	450	290	420	260	30	1040	1290	1385	3.0 / 9.0	1(3)-phase	285	120	120	30
NA 60/45(LS)	450	350	500	350	60	1100	1370	1475	6.0 / 12.0	3-phase	350	120	240	30
NA 120/45(LS)	450	450	600	450	120	1250	1550	1550	9.0 / 18.0	3-phase	460	60	240	30
NA 250/45(LS)	450	600	750	600	250	1350	1650	1725	12.0 / 24.0	3-phase	590	60	120	30
NA 500/45(LS)	450	750	1000	750	500	1550	1900	1820	18.0 / 24.0	3-phase	750	60	240	30
NA 675/45(LS)	450	750	1200	750	675	1550	2100	1820	24.0 / 30.0	3-phase	900	90	270	60
NA 15/65 ¹	650	295	340	170	15	470	790	460	2.8	1-phase	60	40	-	-
NA 30/65	650	290	420	260	30	870	1290	1385	6.0	3-phase ²	285	120	270	60
NA 60/65	650	350	500	350	60	910	1390	1475	9.0	3-phase	350	120	270	60
NA 120/65	650	450	600	450	120	990	1470	1550	12.0	3-phase	460	60	300	60
NA 250/65	650	600	750	600	250	1170	1650	1680	20.0	3-phase	590	90	270	60
NA 500/65	650	750	1000	750	500	1290	1890	1825	27.0	3-phase	750	60	240	60
NA 675/65	650	750	1200	750	675	1290	2100	1825	27.0	3-phase	900	90	270	90
N 30/85 HA	850	290	420	260	30	607 + 255	1175	1315	5.5	3-phase ²	195	180	900	90
N 60/85 HA	850	350	500	350	60	667 + 255	1250	1400	9.0	3-phase	240	150	900	120
N 120/85 HA	850	450	600	450	120	767 + 255	1350	1500	13.0	3-phase	310	150	900	120
N 250/85 HA	850	600	750	600	250	1002 + 255	1636	1860	20.0	3-phase	610	180	900	180
N 500/85 HA	850	750	1000	750	500	1152 + 255	1886	2010	30.0	3-phase	1030	180	900	210
N 675/85 HA	850	750	1200	750	675	1152 + 255	2100	2010	30.0	3-phase	1350	210	900	210

¹Table-top model see page 38

²Heating only between two phases

³Depending on furnace design connected load might be higher

⁴Additional equipment

*Please see page 79 for more information about supply voltage

⁵Empty furnace

⁶External dimensions vary when furnace is equipped with additional equipment. Dimensions on request.

Forced Convection Chamber Furnaces > 1000 Liters Electrically Heated or Gas-Fired



Forced convection chamber furnace
N 3920/26HAS



Enclosed heater coils on electrically
heated models



Compact burners for standard models up
to NB 600



Forced convection chamber furnace
N 1500/85HA with electric charging system for
heavy loads

These forced convection chamber furnaces are available for maximum operating temperatures of 260 °C, 450 °C, 600 °C or 850 °C and are perfectly suited for demanding processes. Due to their robust and solid design even heavy loads can be heat treated. These furnaces are suited for use with baskets, pallets, and mobile furnace racks. The charging can be carried out with fork lift, pallet truck, or charging trolley. The basic forced convection chamber furnaces are standing on the shop floor without bottom insulation. Charging can be simplified by roller conveyors, if necessary also motorized. All furnaces are available with electric heating or gas heating.

Standard version for models up to 600 °C (850 °C models see page 42)

- Tmax 260 °C, 450 °C or 600 °C
- Electrically heated or gas-fired
- Electric heating by means of heater coils
- Direct gas heating or upon request with indirect gas heating with radiation tube, e.g. for heat treatment of aluminum
- Optimal air circulation for your charge by means of adjustable air outlets
- Horizontal air circulation (type ../HA)
- High air exchange for perfect heat transfer
- Ground level charging without bottom insulation for 260 °C models
- Only fiber materials are used which are not classified as carcinogenic according to TRGS 905, class 1 or 2
- Temperature uniformity up to +/- 5 °C according to DIN 17052-1 see page 74
- Furnace chamber lined with alloy 1.4301 (DIN)
- High quality mineral wool insulation provides for low outer temperatures
- Inside unlocking device for furnaces with walk-in work space
- Furnace sizes suitable for common charging systems, such as pallets, baskets, etc.



Forced convection chamber furnace N 6600/60HAS with 4 separated doors and removable charging frame

- Double-wing door for furnaces with an internal width of more than 1500 mm (260 °C and 450 °C models). Furnaces for higher temperatures and with smaller sizes are equipped with a single-wing door.
- Over-temperature limiter with adjustable cutout temperature for thermal protection class 2 in accordance with EN 60519-2 as temperature limiter to protect the furnace and load
- Defined application within the constraints of the operating instructions
- NTLog Basic for Nabertherm controller: recording of process data with USB-flash drive
- Controls description see page 78

Additional equipment for models up to 600 °C

- Optional floor insulation provides for improved temperature uniformity for 260 °C models
- Entry ramps or track cutouts for floor-level charging cart of models with bottom insulation (not for 600 °C models)
- Furnace positioned on base frame provides for ergonomic charging height
- Electro-hydraulic lift door
- Fan system for faster cooling with manual or motor-driven control
- Motor-driven control of air inlet and exhaust air flaps for better ventilation of the furnace chamber
- Observation window and/or furnace chamber lighting (not for 600 °C models)
- Optimization of the temperature uniformity up to +/- 3 °C according to DIN 17052-1 see page 74
- Safety technology according to EN 1539 for charges containing solvents (not for 600 °C models) see page 55
- Charging systems or roller conveyors, also electrically driven provide for easy charging
- Catalytic or thermal exhaust gas cleaning systems
- Process control and documentation via VCD software package or Nabertherm Control Center (NCC) for monitoring, documentation and control see page 78



Forced convection chamber furnace with guide-in tracks to load two charging racks beside each other with a forklift



Pull-out drawers for heavy loads

Forced Convection Chamber Furnaces > 1000 Liters

Electrically Heated or Gas-Fired



N 1000/45HA



N 24500/20HAS

Standard version for models 850 °C

- Tmax 850 °C
- Electrically heated or gas-fired
- Electric heating with heating elements on supports tubes
- Direct gas heating into the outlet of the air circulation fan
- Optimal air circulation for your charge by means of adjustable air outlets
- Horizontal air circulation (type ../HA)
- High air exchange provides for perfect heat transfer
- Base frame with 500 mm charging height
- Temperature uniformity up to +/- 5 °C according to DIN 17052-1 see page 74
- Air baffles made of 1.4828 (DIN)
- Multi-layer insulation with fiber plates provides for low outer temperatures. Only fiber materials are used which are not classified as carcinogenic according to TRGS 905, class 1 or 2.
- Furnaces sizes perfectly suited to accommodate common charging systems, e.g. like pallets or pallet boxes
- Over-temperature limiter with adjustable cutout temperature for thermal protection class 2 in accordance with EN 60519-2 as temperature limiter to protect the furnace and load
- Defined application within the constraints of the operating instructions
- NTLog Basic for Nabertherm controller: recording of process data with USB-flash drive
- Controls description see page 78



N 670/65HAS with quenching tank

Additional equipment for models 850 °C

- Electro-hydraulic lift door
- Fan system for faster cooling with manual or motor-driven control
- Motor-driven air inlet and control of exhaust air flaps for better ventilation of the furnace chamber
- Optimization of the temperature uniformity up to +/- 3 °C according to DIN 17052-1 see page 74
- Base frame for customized charging height
- Charging systems or roller conveyors, also electrically driven provide for easy charging
- Designed for Tmax 950 °C
- Process control and documentation via VCD software package or Nabertherm Control Center (NCC) for monitoring, documentation and control see page 78



Track cutouts for pallet truck or charging cart



Forced convection chamber furnace N 24800/45AS with two lift-doors and rails for interchangeable charging

Model	Tmax °C	Inner dimensions in mm			Volume in l	Outer dimensions ³ in mm			Circulation rate m ³ /h	Heating power in kW ²	Electrical connection*
		w	d	h		W	D	H			
N 1000/26HA	260	1000	1000	1000	1000	1930	1900	1600	3600	15	3-phase
N 1500/26HA	260	1500	1000	1000	1500	2380	1900	1600	3600	18	3-phase
N 1500/26HA1	260	1000	1500	1000	1500	1880	2400	1600	3600	18	3-phase
N 2000/26HA	260	1500	1100	1200	2000	2380	2000	1800	6400	18	3-phase
N 2000/26HA1	260	1100	1500	1200	2000	1980	2400	1800	6400	18	3-phase
N 2010/26HA	260	1000	1000	2000	2000	1880	1900	2720	7200	24	3-phase
N 2880/26HA	260	1200	1200	2000	2880	2080	2100	2720	7200	48	3-phase
N 4000/26HA	260	1500	2200	1200	4000	2380	3110	1800	9000	42	3-phase
N 4000/26HA1	260	2200	1500	1200	4000	3080	2410	1800	9000	42	3-phase
N 4010/26HA	260	1000	2000	2000	4000	1880	2900	2720	12800	48	3-phase
N 4010/26HA1	260	2000	1000	2000	4000	2880	1900	2720	12800	48	3-phase
N 4500/26HA	260	1500	1500	2000	4500	2380	2400	2720	12800	48	3-phase
N 5600/26HA	260	1500	2500	1500	5600	2110	3180	2340	18000	60	3-phase
N 6750/26HA	260	1500	3000	1500	6750	2110	3680	2340	19200	90	3-phase
N 7200/26HA	260	2000	1500	2400	7200	2610	2410	3000	18000	84	3-phase
N 10000/26HA	260	2000	2500	2000	10000	2610	3180	2840	25600	96	3-phase
N 1000/45HA(E ¹)	450	1000	1000	1000	1000	1930	1900	1600	3600	15' / 36	3-phase
N 1500/45HA(E ¹)	450	1500	1000	1000	1500	2380	1900	1600	3600	18' / 36	3-phase
N 1500/45HA1(E ¹)	450	1000	1500	1000	1500	1880	2400	1600	3600	18' / 36	3-phase
N 2000/45HA(E ¹)	450	1500	1100	1200	2000	2380	2000	1800	6400	18' / 42	3-phase
N 2000/45HA1(E ¹)	450	1100	1500	1200	2000	1980	2400	1800	6400	18' / 42	3-phase
N 2010/45HA(E ¹)	450	1000	1000	2000	2000	1880	1900	2720	7200	24' / 48	3-phase
N 2880/45HA(E ¹)	450	1200	1200	2000	2880	2080	2100	2720	7200	48' / 60	3-phase
N 4000/45HA(E ¹)	450	1500	2200	1200	4000	2380	3110	1800	9000	42' / 60	3-phase
N 4000/45HA1(E ¹)	450	2200	1500	1200	4000	3080	2410	1800	9000	42' / 60	3-phase
N 4010/45HA(E ¹)	450	1000	2000	2000	4000	1880	2900	2720	12800	48' / 60	3-phase
N 4010/45HA1(E ¹)	450	2000	1000	2000	4000	2880	1900	2720	12800	48' / 60	3-phase
N 4500/45HA(E ¹)	450	1500	1500	2000	4500	2380	2400	2720	12800	48' / 60	3-phase
N 5600/45HA(E ¹)	450	1500	2500	1500	5600	2110	3180	2340	18000	60' / 84	3-phase
N 6750/45HA(E ¹)	450	1500	3000	1500	6750	2110	3680	2340	19200	90' / 108	3-phase
N 7200/45HA(E ¹)	450	2000	1500	2400	7200	2610	2410	3000	18000	84' / 108	3-phase
N 10000/45HA(E ¹)	450	2000	2500	2000	10000	2610	3180	2840	25600	96' / 120	3-phase
N 1000/60HA	600	1000	1000	1000	1000	1930	1900	1600	3600	36	3-phase
N 1500/60HA	600	1500	1000	1000	1500	2380	1900	1600	3600	36	3-phase
N 1500/60HA1	600	1000	1500	1000	1500	1930	2400	1600	3600	36	3-phase
N 2000/60HA	600	1500	1100	1200	2000	2380	2000	1800	6400	42	3-phase
N 2000/60HA1	600	1100	1500	1200	2000	1980	2400	1800	6400	42	3-phase
N 4000/60HA	600	1500	2200	1200	4000	2380	3110	1800	9000	60	3-phase
N 4000/60HA1	600	2200	1500	1200	4000	3080	2410	1800	9000	60	3-phase
N 1000/85HA	850	1000	1000	1000	1000	2100	2000	1900	3400	40	3-phase
N 1500/85HA	850	1500	1000	1000	1500	2600	2000	1900	6400	40	3-phase
N 1500/85HA1	850	1000	1500	1000	1500	2100	2600	1900	6400	40	3-phase
N 2000/85HA	850	1500	1100	1200	2000	2600	2100	2100	9000	60	3-phase
N 2000/85HA1	850	1100	1500	1200	2000	2200	2800	2100	9000	60	3-phase
N 4000/85HA	850	1500	2200	1200	4000	2600	3400	2100	12600	90	3-phase



Drive-in ramps at furnaces with bottom insulation for processes which require a good temperature uniformity



Forced convection furnace N 4010/45HA with track cutouts, chamber lighting and observation window

¹Reduced connected power for plastics applications

*Please see page 79 for more information about supply voltage

²Depending on furnace design connected load might be higher

³External dimensions vary when furnace is equipped with additional equipment. Dimensions on request.

Forced Convection Bogie Hearth Furnaces Electrically Heated or Gas-Fired

The forced convection bogie hearth furnaces W 1000/60A - W 8300/85A are used when heavy charges weighing up to more than 25 t have to be heat-treated. They are ideal for processes such as solution annealing, artificial ageing, annealing or soft annealing, for which a high degree of temperature uniformity is crucial. The high-performance air circulation assures that the temperature uniformity achieved throughout the work space is outstanding. A broad selection of additional equipment enables these bogie hearth furnaces to be optimally adapted to suit specific processes.

- Tmax 600 °C or 850 °C
- Dual shell housing with rear ventilation provides for low shell temperatures for the 850 °C models
- Swing door hinged on the right side
- Heating from chrome steel heating elements for the 600 °C models
- Heating from three sides (both side walls and the trolley) for the 850 °C models
- High-performance air circulation fan with vertical circulation
- Temperature uniformity up to +/- 5 °C according to DIN 17052-1 see page 74
- Bottom heating protected by SiC tiles on the bogie providing level stacking surface for the 850 °C models
- Furnace chamber fitted with inner sheets made of stainless steel 1.4301 for 600 °C models and of 1.4828 for 850 °C models

- Insulation structured with high-quality mineral wool for 600 °C models
- Only fiber materials are used which are not classified as carcinogenic according to TRGS 905, class 1 or 2
- Bogies with flanged wheels running on rails for easy and precise movement of heavy loads
- Electric chain-driven bogie in combination with rail operation for smooth movement of heavy loads from model W 4800

- Over-temperature limiter with manual reset for thermal protection class 2 in accordance with EN 60519-2 as temperature limiter to protect the furnace and load
- Defined application within the constraints of the operating instructions
- NTLLog Basic for Nabertherm controller: recording of process data with USB-flash drive
- Controls description see page 78



Forced convection bogie hearth furnace W 12500/85AS with grid for heavy loads



Forced convection bogie hearth furnace W 5290/85 AS with annealing box for heat treatment of coils under protective gas



Cooling fan for accelerated cooling

Additional equipment

- Direct gas heating or upon request with indirect gas heating with radiation tube
- Electric chain-driven bogie in combination with rail operation for smooth movement of heavy loads up to Model W 4000
- Optimization of the temperature uniformity up +/- 3 °C according to DIN 17052-1 see page 74
- Bogie running on steel wheels with gear rack drive, no rails in front of the furnace necessary
- Different possibilities for an extension to a bogie hearth furnace plant:
 - Additional bogies
 - Bogie transfer system with parking rails to exchange bogies running on rails or to connect multiples furnaces
 - Motor-driven bogies and cross-traversal system
 - Fully automatic control of the bogie exchange
- Electro-hydraulic lift door
- Motor-driven exhaust air flaps, adjustable via the program
- Uncontrolled or controlled cooling system with frequency-controlled cooling fan and motor-driven exhaust air flap
- Multi-zone control adapted to the particular furnace model provides for optimum temperature uniformity in the 850 °C models
- Commissioning of the furnace with test firing and temperature uniformity measurement (also with load) for the purpose of process optimization
- Designed for Tmax 950 °C, fan blade driven indirectly via a belt to protect the air recirculation motor against over-heating
- Process control and documentation via VCD software package or Nabertherm Control Center (NCC) for monitoring, documentation and control see page 78



Forced convection bogie hearth furnace W 3900/85AS



Forced convection bogie hearth furnace W 24750/60AS

Model	Tmax °C	Inner dimensions in mm			Volume in l	Outer dimensions ² in mm			Heating power in kW ¹	Electrical connection*
		w	d	h		W	D	H		
W 1000/.. A	600	800	1600	800	1000	1800	2390	2305	45	3-phase
W 1600/.. A	600	1000	1600	1000	1600	2000	2390	2535	45	3-phase
W 2200/.. A	600	1000	2250	1000	2200	2000	3040	2535	90	3-phase
W 3300/.. A	600	1200	2250	1200	3300	2200	3040	2745	90	3-phase
W 4000/.. A	600	1500	2250	1200	4000	2500	3040	2780	110	3-phase
W 4800/.. A	600	1200	3300	1200	4800	2200	4090	2780	110	3-phase
W 6000/.. A	600	1500	3300	1200	6000	2500	4090	2900	140	3-phase
W 6600/.. A	600	1200	4600	1200	6600	2200	5390	2770	140	3-phase
W 7500/.. A	600	1400	3850	1400	7500	2400	4640	2980	140	3-phase
W 8300/.. A	600	1500	4600	1200	8300	2500	5390	2780	185	3-phase
W 1000/.. A	850	800	1600	800	1000	1780	2450	2350	45	3-phase
W 1600/.. A	850	1000	1600	1000	1600	1920	2450	2510	45	3-phase
W 2200/.. A	850	1000	2250	1000	2200	1980	3100	2560	90	3-phase
W 3300/.. A	850	1200	2250	1200	3300	2180	3100	2750	90	3-phase
W 4000/.. A	850	1500	2250	1200	4000	2480	3100	2800	110	3-phase
W 4800/.. A	850	1200	3300	1200	4800	2180	4380	2850	110	3-phase
W 6000/.. A	850	1500	3300	1200	6000	2480	4380	2900	140	3-phase
W 6600/.. A	850	1200	4600	1200	6600	2280	5680	2780	140	3-phase
W 7500/.. A	850	1400	3850	1400	7500	2380	4930	3020	140	3-phase
W 8300/.. A	850	1500	4600	1200	8300	2580	5680	2950	185	3-phase



Charge support made of perforated sheet metal

¹Depending on furnace design connected load might be higher

*Please see page 79 for more information about supply voltage

²External dimensions vary when furnace is equipped with additional equipment. Dimensions on request.

Forced Convection Pit-Type Furnaces

Electrically Heated or Gas-Fired



Forced Convection Pit-Type Furnace
SAH 1780/60S



Forced Convection Pit-Type Furnace
SAH 1700/60S with rolling lid

Due to their robust design, these pit-type furnaces with air circulation are particularly useful for a professional heat treatment demanding optimum temperature uniformity. Production processes such as tempering, solution annealing, artificial ageing, and soft annealing can be realized with these pit-type furnaces.

- Tmax 600 °C or 850 °C
- Useful for heavy charge weights
- Air circulation fans in the furnace lid, high circulation rate



Motor-driven fresh-air and exhaust air flaps

- Heating chamber with air baffle cylinder
- Heating elements on all wall surfaces
- Distribution of air flow through grid at the furnace bottom
- Only fiber materials are used which are not classified as carcinogenic according to TRGS 905, class 1 or 2
- Pneumatic or hydraulic lid lifting device
- Temperature uniformity up to +/- 3 °C according to DIN 17052-1 see page 74
- Defined application within the constraints of the operating instructions
- NTLLog Basic for Nabertherm controller: recording of process data with USB-flash drive
- Controls description see page 78

Additional equipment

- Integral fan for fast cooling
- Optimization of the temperature uniformity up to +/- 2 °C according to DIN 17052-1 see page 74
- Variable rpm converter control of the air circulation velocity for sensitive parts
- Multiple zone control or special air circulation system for optimum temperature uniformity tailored to the charge
- Charge weights up to 7 tons
- Process control and documentation via VCD software package or Nabertherm Control Center (NCC) for monitoring, documentation and control see page 78



Forced convection pit-type furnaces
S 10400/75 AS in production



Forced convection pit-type furnaces
SAH 5600/75 S in production

Model	Tmax °C	Inner dimensions cond. cylinder		Volume in l	Max. charging weight in kg	Outer dimensions ² in mm			Heating power in kW ¹	Electrical connection*
		ø in mm	h in mm			W	D	H		
SAH 200/..	600 or 850	600	800	200	400	1460	1460	1850	27	3-phase
SAH 300/..		600	1000	300	400	1460	1460	2050	27	3-phase
SAH 500/..		800	1000	500	600	1660	1660	2050	36	3-phase
SAH 600/..		800	1200	600	600	1660	1660	2250	54	3-phase
SAH 800/..		1000	1000	800	1000	2000	2000	2050	63	3-phase
SAH 1000/..		1000	1300	1000	1000	2000	2000	2400	81	3-phase
SAH 1280/..		800	1600	1300	800	1660	1660	2800	81	3-phase
SAH 5600/..		1800	2200	5600	5000	2700	3000	3900	120	3-phase

¹Depending on furnace design connected load might be higher

²Please see page 79 for more information about supply voltage

²External dimensions vary when furnace is equipped with additional equipment. Dimensions on request.

Pit-Type and Top-Loading Furnaces with or without Air Circulation Electrically Heated or Gas-Fired

Our top-loading furnaces are perfectly suited for the heat treatment of longer or heavier components. The furnace is usually charged with a factory crane. Due to their high-performance air circulation, the furnaces provide for excellent temperature uniformity up to a maximum temperature of 850 °C. The top-loading furnaces for the temperature range up to 1280 °C provide for very good temperature uniformity due to their five-side heating. Alternatively, these furnaces can also be provided with gas heating. Customized dimensions are designed and produced to accommodate the size and weight of the components to be treated.



Top-loading furnace S 5120/GS1, furnace chamber divided in two sections, split cover

- Tmax 260 °C, 450 °C, 600 °C or 850 °C for furnaces with air circulation
- Tmax 900 °C or 1280 °C for furnaces with radiation heating
- Electrically heated or gas-fired
- Heating from both long sides for furnaces with air circulation
- Heating from all four sides and the bottom with SiC plates in the bottom as level stacking support for models to 900 °C or 1280 °C
- High-quality insulation, adapted to the specific maximum temperature. Only fiber materials are used which are not classified as carcinogenic according to TRGS 905, class 1 or 2.
- Electrohydraulic opening system of the lid with two-hand operation
- Closable air supply vents in the lower area of the furnace chamber
- Closable exhaust air flaps in the lid
- Over-temperature limiter with adjustable cutout temperature for thermal protection class 2 in accordance with EN 60519-2 as temperature limiter to protect the furnace and load
- Defined application within the constraints of the operating instructions



Furnace chamber S 5120/GS with receptacle for an insulating plate in order to divide the furnace chamber

Additional equipment

- Motor-driven exhaust air flaps for faster cooling
- Controlled fan cooling with motor-driven exhaust air flaps
- Multi-zone control of the heating provides for optimum temperature uniformity
- Furnace chamber can be divided in length for short workparts, partitions can be controlled separately
- Designed for Tmax 950 °C, fan blade driven indirectly via a belt to protect the air recirculation motor against overheating
- Process control and documentation via VCD software package or Nabertherm Control Center (NCC) for monitoring, documentation and control see page 78



Charge supports for long tubes in a top-loading forced convection furnace SAL 750/08

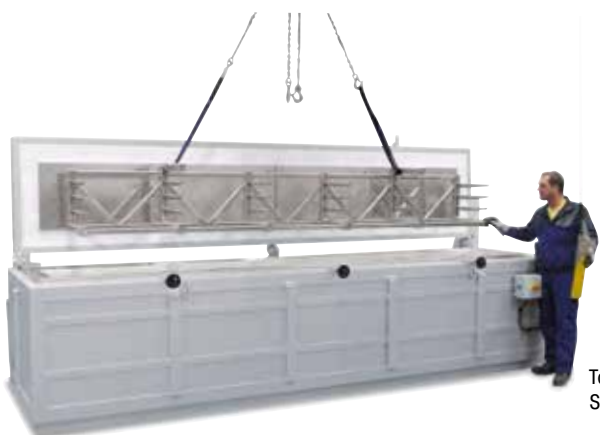

Top-loading furnace SAT 1512/85S



Pit-type furnace S 11988/S with rolling lid

Drop-Bottom Furnaces

Electrically Heated or Gas-Fired

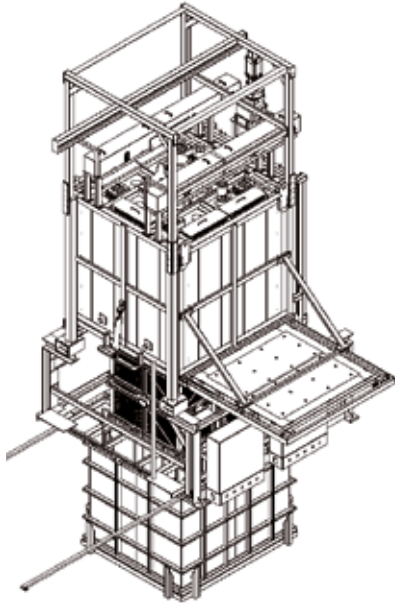

Drop-bottom furnace with stationary quench tank



Fully automatic drop-bottom furnace with movable water bath, including holding position for charging and unloading crane

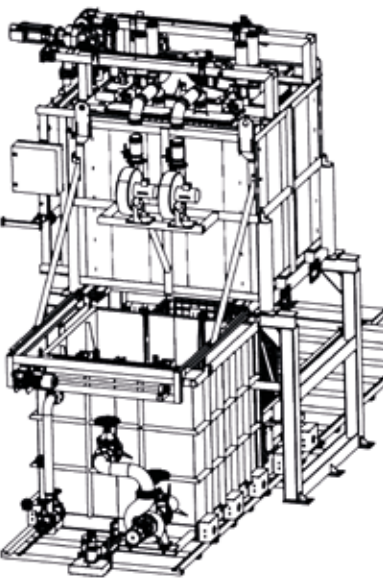

Drop-bottom furnace with movable quench tank, expandable by more furnaces or baths

Drop-bottom furnaces are used for solution annealing and subsequent rapid quenching of aluminum alloys. In particular, with thin-walled aluminum components quench delay times of just 5 seconds from when the door begins to open until complete immersion in the quench tank are required. Generally, these requirements can be met only with this furnace design. The drop-bottom furnace stands on a base so that a quench tank can be positioned directly below the furnace. For the quenching process, the furnace bottom moves horizontally to the side. The loaded basket drops out of the furnace into the quench tank guided by wire cables. The lifting system can be controlled automatically or semi-automatically. Because of the broad working temperature range, drop-bottom furnace plants allow complete T6 heat treatments, consisting of solution annealing, quenching, and artificial aging in just one furnace.

Drop-bottom design alternatives

- Drop-bottom furnace with stationary quench tank as a cost-effective, space saving variant
- Drop-bottom furnace with movable quench tank, including holding position for charging and optional unloading crane
- Customized designs with several furnaces, several tanks and several holding positions for fully automatic processing of several charges

System details

- Working temperature range between 80 °C and 600 °C
- Working temperature can be extended to 650 °C
- Heating generally electric; direct or indirect gas heating is also possible
- Air flow, depending on space conditions and charge geometry, horizontal or vertical
- Compliance with relevant aircraft and automobile standards, such as AMS 2750 E, AMS 2770/2771, or CQI-9 as an option



Fully automatic drop-bottom furnace plant, consisting of two drop-bottom furnaces, movable water bath and several loading and unloading positions

Quench Tanks

Water or polymer quench tanks have a single stainless steel wall and have an integrated circulation system of the quenching medium for effective removal of energy from the charge. Temperature and level are monitored. All tanks have connections for water feed and drainage and a heat exchanger. On request, the quench tank can be equipped with a controlled heating to preheat the quenching medium and/or a heat exchanger for cooling. If the quenching medium is to be kept continuously at a high temperature, a tank insulation with or without cover is recommended.

Based on Siemens PLC technology the system is operated conveniently with PC-based Nabertherm Control Center software. Components can also be moved manually via a Mobile Panel.

Customized drop-bottom designs are tailored and manufactured to customer needs.

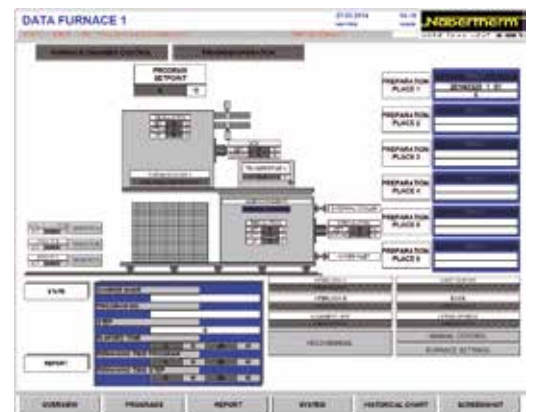

Control, visualization and documentation with Nabertherm Control Center NCC

Size examples Model	Tmax °C	Work space dimensions in mm			Volume in l	Outer dimensions ² in mm		Heating power in kW ¹	Electrical connection*
		w	d	h		H	H		
FS 1200/60A	600	600	600	1000	1200	4870**	36	3-phase	
FS 4000/60HA	600	1100	1100	1100	4000	5700**	96	3-phase	
FS 5600/60A	600	1400	1400	1100	5600	5700**	120	3-phase	

¹Depending on furnace design connected load might be higher

²External dimensions vary when furnace is equipped with additional equipment. Dimensions on request.

*Please see page 79 for more information about supply voltage

**With quench tank on cart

***Quench tank mounted on the floor

Quench and Temper Plants for Steel



Fully automated tempering plant with two chamber furnaces, quench bath, conveyor system, and parking spots for four charge baskets



Annealing furnace with manipulator

To temper steel, after annealing the furnace is opened at working temperatures of more than 1000 °C. The lift door opens and the manipulator places the charge into the quenching medium. After quenching the charge is placed into the forced convection chamber furnace for tempering. Good temperature uniformity is important.

Oil or water is used as a quenching medium. Depending on the steel grade and the required cooling rate, the charge can also be force-cooled or quenched in an air quenching chamber.

Alternative plant designs are tailored to process requirements. For lighter charge weights a manual tempering plant can be used, consisting of an annealing furnace, quench tank and manual manipulator. Semi-automatic or fully automatic plants are used for heavy loads and high throughput rates. The charge is placed into the hot furnace and subsequently into the quench tank by a manipulator.

The customer specifies the needed quenching delay time for the individual process counting from opening the furnace door until the charge is completely immersed in the quenching medium. Fast delay times are only possible with a powered manipulator. If the quenching delay time is not so critical, for example for heavy and thick-walled parts, bogie hearth furnaces can also be used. The bogie is driven out of the furnace electrically and the components can be transferred and quenched by a crane.



Tempering plant with top hat furnace H 4263/12S and water bath

Top hat furnaces are suitable for long components or for processes with no need for short quenching delay times. The top hat is opened while the furnace is hot and the charge is then transferred and quenched by the customer's crane with a C-hook.

Annealing Furnace Design Alternatives

- Chamber furnace with radiation heating and a lift door for charging with a manipulator
- Bogie hearth furnace with powered bogie for charging with a crane for low quenching delay time requirements
- Top hat furnace for long components, such as rod material for charging with a crane and C-hook

Quenching Design Alternatives

- Quench tanks with water, oil or polymer as a quenching medium
- Cooling station with powerful fan cooling for air quenching.

Charge Transfer Alternatives

- Manual manipulator for manual tempering plants
- Electric manipulator for manual tempering plants
- Rail-mounted 2-axle manipulator, semi-automatic for charging, unloading and quenching the charge in a liquid medium
- Rail-mounted 2-axle manipulator, semi-automatic or fully automatic for charging, unloading, quenching, subsequent tempering in forced convection furnace or transferring to a holding position



The charge is placed in the hot furnace by a manipulator and is also removed and transferred to the quenching medium while it is hot.

Quench Tanks





Oil quenching bath OAB 67000 with heat exchanger and a volume of 67.000 liters oil

Subject to process, charge size and weight a customized quench bath will be designed and delivered. Standard sizes are also available. Water, oil or polymer are available as quenching medium.

Available quenching mediums:

- Water
- Oil
- Polymer

Design Specifications

- Powerful circulation of the quenching medium
- Controlled heating systems
- Lowering devices for the charge
- Fill-level control
- Automatic refill system in case of water as quenching medium
- Connection port for customer's cooling system
- Cooling system of the quenching medium via heat exchanger
- Oil separator for quench tanks with water
- Protective gas supply on the surface of oil quench tanks as fire protection
- Integration of bath temperature in the process control and documentation



Powerful circulation of quenching medium



Combined oil quenching and cleaning bath with immersible tables, protection cover, oil separator and exhaust system

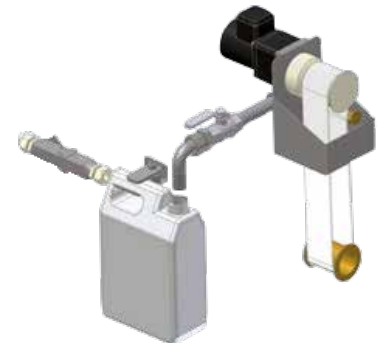

Oil separator for quench tanks with water



Chamber Furnaces Gas-Fired



Chamber furnace NB 2880/S



Chamber furnace NB 4330/S

Certain heat treatment processes require a gas-fired chamber furnace. Short heating times due to the high power are a convincing argument. The chamber furnaces with powerful atmospheric gas burners cover a wide variety of these processes. In the basic version the burners are manually ignited once at the start of the process. The automatic control system then takes over control of the temperature curve. At program end, the burners are automatically switched off. Depending on the process, the furnaces can be equipped with automatically controlled fan burners and safety technology for debinding. Depending on the model, these furnaces can be upgraded with fully automatic fan burners and additional accessories.



Indirect gas firing with radiation tubes



Compact burners for standard models up to NB 600

- Tmax 1300 °C
- Powerful, atmospheric burners for operation with liquified gas or natural gas
- Depending on the application, special positioning of the gas burners with flame guidance provides for optimal temperature uniformity
- Fully automatic temperature control
- Gas fittings with flame control and safety valve in accordance with DVGW (German Technical and Scientific Association for Gas and Water)
- Multi-layer, reduction-proof insulation with light-weight refractory bricks and special back-up insulation result in low gas consumption
- Self-supporting and rugged ceiling, bricks laid in arched construction. Only fiber materials are used which are not classified as carcinogenic according to TRGS 905, class 1 or 2.
- Exhaust hood
- Over-temperature limiter with adjustable cutout temperature for thermal protection class 2 in accordance with EN 60519-2 as temperature limiter to protect the furnace and load
- Defined application within the constraints of the operating instructions
- Controls description see page 78

Additional equipment

- Fan burner with fully automatic control
- Indirect gas firing with radiation tubes for flame protection of the charge
- Exhaust air and exhaust gas piping
- Thermal or catalytic exhaust cleaning systems
- Recuperator technology for heat recovery see page 83
- Process control and documentation via VCD software package or Nabertherm Control Center (NCC) for monitoring, documentation and control see page 78

Forced Convection Chamber Furnaces/Dryers with Safety Technology for Solvent-Containing Charges according to EN 1539 or NFPA 86



Ship-lock type furnace N 560/ 6HACLS with safety technology, front charging and rear unloading



Electrically heated chamber oven KTR 1500 for drying of foundry cores with an alcohol-based binder

Safety Technology for Forced Convection Chamber Furnaces

Certain processes release and vaporize solvents or other flammable vapors. The concentration of these vapors must be kept below a certain limit to prevent ignition. European Norm EN 1539 and NFPA 86 in the USA prescribe the required safety equipment for these processes.

For these applications and processes, all forced convection furnaces of the KTR and forced convection chamber furnaces < 450 °C product lines are suited with safety technology for protection of a potential ignition in the furnace chamber.

To avoid an ignition in the furnace, flammable vapors must be diluted with air. Special care must be taken so high concentrations of flammable materials do not accumulate in "dead" areas within the furnace. For this purpose, the furnaces are equipped with an exhaust gas fan providing for a defined underpressure. A measurement system monitors this flow, while fresh air is simultaneously resupplied. In parallel, the furnace atmosphere is diluted by the inflow of fresh air. The air circulation is also monitored by the measurement system.

- Furnace sizes between 120 and 10,000 liters
- Powerful exhaust fan capable of maintaining underpressure in the furnace
- Defined and monitored air circulation flow and exhaust air
- Visual and audible emergency signals
- Over-temperature limiter with adjustable cutout temperature for thermal protection class 2 in accordance with EN 60519-2 as temperature limiter to protect the furnace and load



Exhaust port and powerful exhaust fan mounted on the furnace



Guide-in tracks for chamber ovens with bottom insulation

Chamber Furnaces for Heat Cleaning

Gas-Fired with Integrated Thermal Post Combustion



Chamber furnace NB 2300 CL



Chamber furnace NB 2750/65 CL



Before



After

The chamber furnaces in the model series NB .. CL are used for heat cleaning of components. An optimum temperature uniformity is not a priority for these processes. Examples are heat cleaning of electric motors, coated surfaces of steel components or the nozzles of plastic injection molding machines.

The furnaces are gas-fired and have an integrated thermal post combustion system which is also gas-fired. The pre-set, low-oxygen respectively reducing atmosphere in the chamber furnace effectively prevents spontaneous combustion at the workpiece and subsequent damage as a result of over-temperature.

For safe operation, the furnace door locks after program start and cannot be opened again until the temperature has dropped below 180 °C at the process end. In case of a burner flame malfunction or gas shortage the process is aborted. In addition, the control system is equipped with an over-temperature limiter with manual reset that is set by the customer at a safe cut-off temperature to switch off the chamber furnace if the limit is exceeded.

The chamber furnaces are not suitable for components and coatings that contain solvents or a high concentration of water. These models must also not be used for charges with low flash points such as wood, paper or wax.

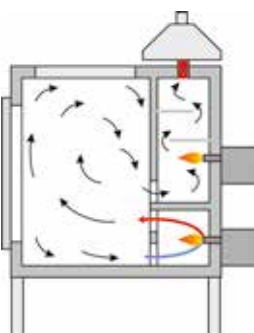

- Tmax 500 °C
- Furnace chamber size dimensioned to hold standard lattice boxes
- Only fiber materials are used which are not classified as carcinogenic according to TRGS 905, class 1 or 2, bottom and rear wall insulated with lightweight refractory bricks
- High performance, atmospheric burner fueled by liquified gas or natural gas
- Completely automated temperature controls
- Integrated thermal post combustion for exhaust gas cleaning
- Defined application within the constraints of the operating instructions
- Controls description see page 78



Gas burners for furnace heating and thermal post combustion

Model	Tmax °C	Inner dimensions in mm			Outer dimensions ¹ in mm			Burner rating furnace chamber in kW	Burner rating TNV in kW
		w	d	h	W	D	H		
NB 1300 CL	500	1200	900	1000	2160	2310	2450	50	100
NB 2300 CL	500	1200	1200	1600	2160	2605	3050	100	100
NB 2500 CL	500	1200	1600	1300	2160	3000	2750	100	100
NB 2750/65 CL	650	1200	1200	1900	2160	2605	3150	100	80

¹External dimensions vary when furnace is equipped with additional equipment. Dimensions on request.

Chamber Furnaces for Processes with High Vaporization Rates of Organic Matter or for Thermal Cleaning by Ashing

Electrically Heated or Gas-Fired

The chamber furnaces of the model series N(B) .. BO are used for processes with large amounts of organic matters or high vaporization rates. These models can be used for products which are insensitive against temporarily uncontrolled temperature increases. Processes in which the product or contaminations on the product are ashed by ignition can be also carried out safely in this type of chamber furnace. Examples include residual wax removal of pouring clusters followed by sintering, or thermal cleaning of oxide catalytic honey combs from soot or fuel residues. The electrically heated N...BO furnaces can be used for processes with exact temperature control and uniformity. For safety reasons, they are equipped with an integrated gas torch for igniting the flammable components in the gas mixture. The accumulation of flammable components is avoided and their safe combustion is ensured.

The gas-fired NB...BO furnaces are designed for processes which require a heat-up time to temperatures > 500 °C

The burning of unwanted organic ingredients can take place at temperatures > 500 °C. Following this, a subsequent process can take place up to max. 1400 °C (electrically) or up to 1000 °C (gas-fired).

For safety, the furnace door locks after the program was started and cannot be opened again until the temperature has dropped below a defined value. In case of burner malfunction or gas shortage the process is aborted.

Chamber furnaces N 100 BO - N 650/14 BO, electrically heated and gas-fired ignition flame

- Tmax 1000 °C or 1400 °C
- Only fiber materials are used which are not classified as carcinogenic according to TRGS 905, class 1 or 2
- Standard sizes up to 650 liters furnace chamber, additional sizes on request
- Exhaust hood
- Fully automatic temperature control
- Optional thermal post combustion
- Ignition flame using natural gas or liquid gas (LPG)
- Defined application within the constraints of the operating instructions
- Controls description see page 78

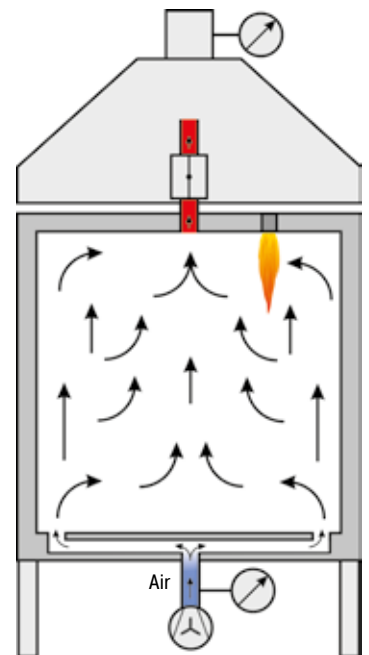

Model	Tmax °C	Inner dimensions in mm			Outer dimensions ² in mm			Heating power in kW ¹
		w	d	h	W	D	H	
N 100 BO	1000	400	530	460	1200	1300	2100	9
N 300 BO	1000	550	700	780	1350	1450	2200	20
N 300/14 BO	1400	550	700	780	1350	1450	2200	30
N 650/14 BO	1400	700	850	1100	1700	1900	2700	62

¹Depending on furnace design connected load might be higher

²External dimensions vary when furnace is equipped with additional equipment. Dimensions on request.

Chamber furnaces models NB 300 BO and NB 650 BO, gas-fired

- Tmax 1000 °C
- Only fiber materials are used which are not classified as carcinogenic according to TRGS 905, class 1 or 2
- Standard sizes up to 650 liters furnace chamber, additional sizes on request
- Integrated thermal post combustion
- Gas burners operating with natural gas or liquid gas (LPG)
- Defined application within the constraints of the operating instructions
- Controls description see page 78

Model	Tmax °C	Inner dimensions in mm			Outer dimensions ¹ in mm			Output burner in kW
		w	d	h	W	D	H	
NB 300 BO	1000	550	700	780	1250	1650	3000	100
NB 650 BO	1000	700	850	1100	1600	2100	3150	200

¹External dimensions vary when furnace is equipped with additional equipment. Dimensions on request.



Chamber furnace N 650/14 BO with ignition burner

Dewaxing Furnaces Electrically Heated



Dewaxing furnace N 300/WAX

These dewaxing furnaces are especially designed for dewaxing and subsequent firing of the ceramic form. The electrically heated models are operated below the ignition point of the wax during dewaxing. The dewaxing furnaces have a heated stainless steel drain in the bottom of the furnace chamber, formed as a funnel with the discharge near the center of the furnace. The stainless steel grids in the bottom can be removed for cleaning. There is a tight stainless steel container under the dewaxing furnace with a removable drawer for wax collection. After the dewaxing process is finished the furnace continues heating in order to sinter the molds.

- Tmax 850 °C
- Chamber furnace with wide-opening swinging door
- Four side heating with freely radiating heating elements on ceramic support tubes



Grid bottom



Drain pan in floor



Drawer for collection of liquid wax

- Heated drainage in floor, controlled by a separate controller up to a maximum of 200 °C, to reliably prevent freezing of the draining wax - Release of furnace heating only possible after drain temperature is reached, to prevent clogging
- Stainless steel floor pan with grid bottom for level loading
- Rugged self-supporting, vaulted arch construction
- Exhaust gas vent in furnace ceiling for connection with ductwork
- Air inlet openings for reliable air exchange
- Only fiber materials are used which are not classified as carcinogenic according to TRGS 905, class 1 or 2
- Dual shell furnace housing for low exterior temperatures
- Removable base included in delivery (fixed base for models N 440 and larger)
- First over-temperature limiter which must be set below the ignition point of the wax and prevents the wax from igniting during dewaxing. It is customers responsibility to set the required time interval for dewaxing. After this time has elapsed the over-temperature limiter will be deactivated to make sure that the furnace can continue with the sintering process.
- Second over-temperature limiter with adjustable cutout temperature for thermal protection class 2 in accordance with EN 60519-2 as temperature limiter to protect the furnace and load
- Defined application within the constraints of the operating instructions
- NTLog Basic for Nabertherm controller: recording of process data with USB-flash drive
- Controls description see page 78

Model	Tmax °C	Inner dimensions in mm			Volume in l	Outer dimensions ² in mm			Max. drain-off volume in l	Heating power in kW ¹	Electrical connection*	Weight in kg
		w	d	h		W	D	H				
N 100/WAX	850	400	530	460	100	720	1130	1440	5	7.5	3-phase	340
N 150/WAX	850	450	530	590	150	770	1130	1570	8	9.5	3-phase	360
N 200/WAX	850	500	530	720	200	820	1130	1700	10	11.5	3-phase	440
N 300/WAX	850	550	700	780	300	870	1300	1760	15	15.5	3-phase	480
N 440/WAX	850	600	750	1000	450	1020	1460	1875	17	20.5	3-phase	885
N 660/WAX	850	700	850	1100	650	1120	1560	1975	20	26.5	3-phase	1000
N 1000/WAX	850	800	1000	1250	1000	1580	1800	2400	25	40.5	3-phase	1870
N 1500/WAX	850	900	1200	1400	1500	1680	2000	2550	35	57.5	3-phase	2570
N 2200/WAX	850	1000	1400	1600	2200	1780	2200	2750	50	75.5	3-phase	3170

¹Depending on furnace design connected load might be higher

^{*}Please see page 79 for more information about supply voltage

²External dimensions vary when furnace is equipped with additional equipment. Dimensions on request.

Dewaxing Furnaces Gas-Fired

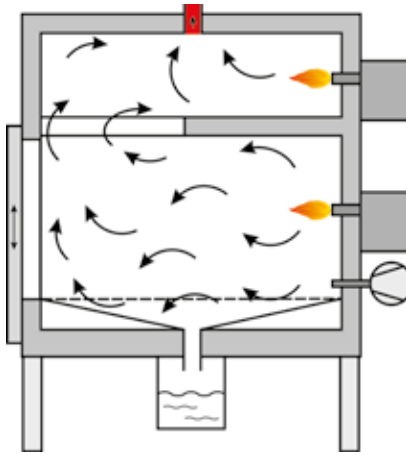

The chamber furnace of NB .. BOWAX series is suitable for Flash Fire processes in which the hot furnace is charged with raping castings.

For a quick loading and unloading, the dewaxing furnace is equipped with a pneumatic lift door, which is controlled via a footswitch.

After charging, the wax liquefies in short time. The first part of the wax flows-out through the integrated pan directly into a catch basin under the dewaxing furnace and is collected safely in a water tank.

The remainder of the wax evaporates in the furnace chamber and is burned safely in the downstream thermal post combustion. The resulting exhaust air is conducted via an exhaust chimney and a secondary customer side piping out of the hall.

In the event of a flame failure of the burner or gas shortage takes place a process termination.

- Tmax 1000 °C
- Standard size with 300 l furnace volume, other sizes on request
- Fully automatic temperature control
- Integrated thermal post combustion incl. Exhaust hood (250 mm)
- Gas burner for operation with natural of LPG gas with permanent monitoring via a PLC
- Only fiber materials are used which are not classified as carcinogenic according to TRGS 905, class 1 or 2
- Pneumatic lift-door with foot-switch and electromagnetic locking
- Withdrawable wax collecting pan under the furnace
- Optical indication when charging temperature has been reached
- Defined application within the constraints of the operating instructions
- NTLog Basic for Nabertherm controller: recording of process data with USB-flash drive
- Controls description see page 78



Dewaxing furnace NB 300/BOWAX



Dewaxing furnace NB 300/BOWAX

Model	Tmax °C	Inner dimensions in mm			Volume in l	Outer dimensions ² in mm			Max. drain- off volume in l	Heating power in kW ¹	Electrical connection*
		w	d	h		W	D	H			
NB 300/BOWAX	1000	550	700	780	300	1010	1700	3030	2	100,0	3-phase

¹Depending on furnace design connected load might be higher

^{*}Please see page 79 for more information about supply voltage

²External dimensions vary when furnace is equipped with additional equipment. Dimensions on request.

Bogie Hearth Furnaces Electrically Heated



Bogie hearth furnace W 2200/S with exchangeable table system



Bogie hearth furnace W 7500 with bogie, separated in three parts



Fiber insulation, classified as non-carcinogenic and meander shaped heating elements for short process times

For annealing and hardening of larger parts, for example heavy cast parts or tool steel dies to temperatures between 800 °C and 1100 °C, we recommend our bogie hearth furnaces with radiation heating. The bogie can be loaded outside the furnace. When the design includes an electro-hydraulic lift door and a motorized bogie, the furnace can be opened while hot and the load can be removed for cooling or quenching. When several bogies are used together with a second door or bogie transfer system, one bogie can be loaded outside the furnace while the other bogie is in the furnace. This shortens process times and the residual energy of the furnace can be used when the new charge is heated.

- Tmax 900 °C or 1280 °C
- Dual shell housing with rear ventilation, provides low shell temperatures
- Swing door hinged on the right side
- Heating from five sides (four sides and bogie) provides for a optimum temperature uniformity
- Bogie heating receives power via blade contacts when driven in
- Heating elements mounted on support tubes provide for free radiation and long service life
- Bottom heating protected by SiC tiles on the bogie providing level stacking surface
- Only fiber materials are used which are not classified as carcinogenic according to TRGS 905, class 1 or 2
- Self-supporting and long-life ceiling construction with bricks laid in arched construction
- Bogies with flanged wheels running on rails for easy and precise movement of heavy loads
- Adjustable air inlet damper
- Manual exhaust air flap on the furnace roof

- Over-temperature limiter with adjustable cutout temperature for thermal protection class 2 in accordance with EN 60519-2 as temperature limiter to protect the furnace and load
- Defined application within the constraints of the operating instructions
- NTLog Basic for Nabertherm controller: recording of process data with USB-flash drive
- Controls description see page 78

Additional equipment

- Electric chain-driven bogie in combination with rail operation for smooth movement of heavy loads
- Bogie running on steel wheels with gear rack drive, no rails in front of the furnace necessary
- Different possibilities for an extension to a bogie hearth furnace plant:
 - Additional bogies
 - Bogie transfer system with parking rails to exchange bogies running on rails or to connect multiples furnaces
 - Motor-driven bogies and cross-traversal system
 - Fully automatic control of the bogie exchange
- Electro-hydraulic lift door
- Motor-driven exhaust air flap
- Uncontrolled or controlled cooling system with frequency-controlled cooling fan and motor-driven exhaust air flap
- Multi-zone control adapted to the particular furnace provides model for optimal the temperature uniformity
- Commissioning of the furnace with test firing and temperature uniformity measurement (also with load) for the purpose of process optimization
- Process control and documentation via VCD software package or Nabertherm Control Center (NCC) for monitoring, documentation and control see page 78



Bogie running on steel wheels with gear rack drive, no rails necessary



Bogie hearth furnace with gas supply system



Bogie-hearth furnace W 2394/S with heat shields

Bogie Hearth Furnaces Electrically Heated



Combi furnace plant consisting of two bogie hearth furnaces W 5000/H and two additional boggies incl. bogie transfer system and incl. necessary park rails

Model	Tmax °C	Inner dimensions in mm			Volume in l	Outer dimensions ² in mm			Heating power in kW ¹	Electrical connection*	Weight in kg
		w	d	h		W	D	H			
W 1000/G	900	800	1600	800	1000	1470	2410	1915	40	3-phase	3000
W 1500/G	900	900	1900	900	1500	1570	2710	2030	57	3-phase	3500
W 2200/G	900	1000	2200	1000	2200	1670	3010	2140	75	3-phase	4500
W 3300/G	900	1000	2800	1200	3300	1670	3610	2355	110	3-phase	5300
W 5000/G	900	1000	3600	1400	5000	1670	4410	2555	140	3-phase	7300
W 7500/G	900	1000	5400	1400	7500	1670	6210	2555	185	3-phase	10300
W 10000/G	900	1000	7100	1400	10000	1670	7910	2555	235	3-phase	12500
W 1000	1280	800	1600	800	1000	1470	2410	1915	57	3-phase	3000
W 1500	1280	900	1900	900	1500	1570	2710	2030	75	3-phase	3500
W 2200	1280	1000	2200	1000	2200	1670	3010	2140	110	3-phase	4500
W 3300	1280	1000	2800	1200	3300	1670	3610	2355	140	3-phase	5300
W 5000	1280	1000	3600	1400	5000	1670	4410	2555	185	3-phase	7300
W 7500	1280	1000	5400	1400	7500	1670	6210	2555	235	3-phase	10300
W 10000	1280	1000	7100	1400	10000	1670	7910	2555	300	3-phase	12500



Bogie hearth furnace W 6340S

¹Depending on furnace design connected load might be higher

^{*}Please see page 79 for more information about supply voltage

²External dimensions vary when furnace is equipped with additional equipment. Dimensions on request.

Gas-Fired Bogie Hearth Furnaces up to 1400 °C for Heat Treatment in Air or under Reducing Atmosphere



Combi furnace plant consisting of one gas-fired bogie hearth furnace WB 11000/HS and two additional bogies incl. bogie transfer system and incl. necessary park rails

Gas-fired bogie hearth furnaces distinguish by their unique efficiency. The use of high-speed burners allows for short heating times. The burners are arranged according to the furnace geometry providing for a optimum temperature uniformity. Depending on the furnace dimensions, the burners can alternatively be equipped with recuperator technology to save energy. The high-quality, long-life fiber insulation, classified as non-carcinogenic, with storage capacity provides for short heating and cooling times.

- Tmax up to 1400 °C, depending on furnace design
- Powerful, sturdy high-speed burner with pulse control and special flame control in the furnace chamber provide for optimum temperature uniformity
- Operation with city gas, natural gas or liquified gas
- Fully automatic PLC control of the temperature as well as monitoring of the burner function
- Reduction-resistant fiber insulation with low heat storage provides for short heating and cooling times. Only fiber materials are used which are not classified as carcinogenic according to TRGS 905, class 1 or 2.
- Dual shell housing provides for low outside temperatures
- Exhaust hood with fittings for further discharge of the exhaust gases
- Over-temperature limiter with adjustable cutout temperature for thermal protection class 2 in accordance with EN 60519-2 as temperature limiter to protect the furnace and load
- Defined application within the constraints of the operating instructions
- Controls description see page 78

Additional equipment

- Automatic lambda control to set the furnace atmosphere
- Exhaust air and exhaust gas piping
- Recuperator burners utilizing part of the waste heat in the exhaust tract to preheat the combustion air and considerably contribute to energy saving
- Thermal exhaust cleaning systems
- Process control and documentation via VCD software package or Nabertherm Control Center (NCC) for monitoring, documentation and control see page 78
- Other additional equipment for bogie hearth furnaces see pages 61



Bogie hearth furnace WB 14880S



Furnace chamber with eight high-speed burners

Catalytic and Thermal Post Combustion Systems, Exhaust Gas Washer



For exhaust gas cleaning, in particular in debinding, Nabertherm offers exhaust gas cleaning systems tailored to the process. The post combustion system is permanently connected to the exhaust gas fitting of the furnace and accordingly integral part of the control system and the safety matrix of the furnace. For existing furnaces, independent exhaust gas cleaning systems are also available that can be separately controlled and operated.

Catalytic post combustion system independent from furnace model for refitting on existing plants

Catalytic post combustion systems (KNV)

Catalytic exhaust cleaning is recommended due to energetic reasons when only pure hydrocarbon compounds must be cleaned during the debinding process in air. They are recommended for small to medium exhaust gas amounts.

- Perfectly suited for debinding processes in air with only organic exhaust gases
- Decomposition of gases in carbon dioxide and water
- Integrated in a compact stainless steel housing
- Electric heating provides for preheating of the exhaust gas to the optimal reaction temperature for catalytic treatment
- Cleaning in different layers of catalytic honeycombs within the system
- Thermocouples for measuring the temperatures of raw gas, reaction honeycombs and discharge
- Over-temperature limiter with adjustable cutout temperature protects the catalyst
- Tight connection between the exhaust gas outlet of the debinding furnace and the exhaust gas fan with corresponding integration into the overall system with respect to control and safety technology
- Catalyst dimensioned in relation to the exhaust gas flow
- Measuring port for clean gas measurements (FID)



Forced convection chamber furnace NA 500/65 DB200 with catalytic post combustion system.

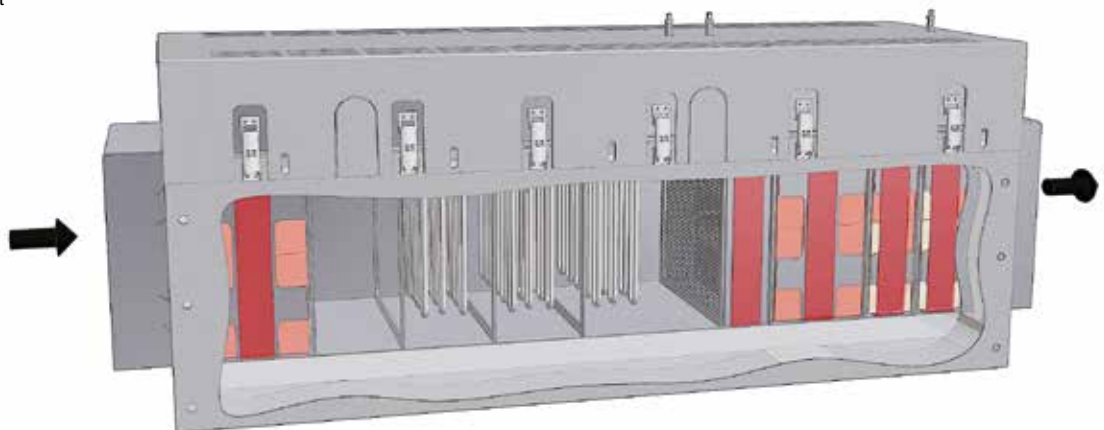

Scheme of a catalytic post combustion system

Thermal post combustion systems (TNV)

Thermal post combustion systems are used if large volumes of exhaust gas from the debinding process in air must be cleaned and/or if there is a risk that the exhaust gases might damage the catalyst. Thermal post combustion is also used for debinding applications under non-flammable or flammable protective or reaction gases.

- Optimally suited for debinding processes in air with large exhaust gas flow, erratic large exhaust gas volumes, large volume flow or for debinding processes under non-flammable or flammable protective or reaction gases
- Gas-fired to burn the exhaust gases
- Burn-off at temperatures up to 850 °C provides for thermal decomposition of the exhaust gases
- Heating with compact gas burner with automatic firing device



Forced convection furnace NA 500/06 DB200-2 with thermal post combustion



- Thermocouples in the combustion chamber and in the raw gas inlet
- Over-temperature limiter for protecting the thermal post combustion
- Design depending on the exhaust gas flow
- Measuring port for clean gas measurements (FID)

Scheme of a thermal post combustion system

Exhaust Gas Washer

An exhaust gas washer will be often used if the generated gases cannot be effectively treated with a thermal post combustion system or with a torch. To clean, detox or decontaminate the exhaust gas stream a liquid is used to wash or neutralize unwanted pollutants. The scrubber can be adapted to the process by designing its liquid distribution and contact area and by selecting the most suitable washing liquid. Liquids may simply be water or special reagents or even suspensions to successfully remove unwanted gases, liquids or particles from the exhaust gas.



Exhaust gas washer to clean generated process gases by washing out

Rotary Hearth Furnaces up to 1300 °C with and without Air Circulation
Electrically Heated or Gas-Fired



Gas-fired rotary-hearth furnaces for preheating of ceramic moulds up to 1100 °C incl. thermal post combustion for exhaust gas cleaning



Rotary Hearth Furnaces up to 1300 °C with and without Air Circulation Electrically Heated or Gas-Fired



Electrically heated rotary hearth furnace with Tmax 1100 °C, movable on rails, for preheating of molds for two forges



Gear rim drive under the rotary hearth furnace



Rotary table with fire-resistant concrete plates to protect the insulation

The rotary hearth furnaces of the DH product line are optimally suited for continuous processes on a small floor space. They are designed for preheating processes such as the preheating of metal parts for forging or for preheating of moulds. Charging and discharging can be done at one position – either by a person or fully automatic. The hearth rotates in pre-set segments individually reconciled with the workpart geometry. The rotational speed and rotational intervals can be defined by the control system or by manual switching.

The rotary hearth furnaces are specifically designed for the required throughput and charge dimensions. They are heated electrically or alternatively gas-fired by means of powerful gas burners. Subject to the temperature range these rotary hearth furnaces are equipped with or without air circulation.

- Tmax > 850 °C up to 1300 °C with radiation heating
- Tmax up to 850 °C with powerful air-circulation for better heat transmission onto the charge and to optimize the temperature uniformity in the low-temperature range
- Electrically heated:
 - Wire heating elements in the furnaces ceiling
 - Heating via SiC rods installed in the furnace ceiling for furnaces up to 1300 °C
- Gas-fired:
 - Directly gas-fired: The burner fires directly in the furnace chamber
 - Indirectly gas-fired: The burner fires in a radiation tube to avoid a direct contact between the charge and the burner exhaust gases
- Very compact design compared with continuous furnaces
- Designed for continuous operation at one working temperature
- Table diameter up to 6000 mm
- Only fiber materials are used which are not classified as carcinogenic according to TRGS 905, class 1 or 2
- Additional water sealing between the rotary table and the housing for forced convection furnaces and directly gas-fired furnaces

- Table drive under the furnace provides for movement in defined segments or continuously
- Low-vibration movement of the rotary hearth
- Charging through a lift-door
- Actuation of rotary drive via foot pedal or external contact in case of automatic operation
- Additional Service door on request
- Controls description see page 78

Additional equipment

- Exhaust hood above the door opening for discharge of the warm exhaust air when door is open
- Charging aids for ease of loading and unloading
- Multi-zone control for uniform thermal profile during the cycle
- Protective gas connections
- Process control and documentation via VCD software package or Nabertherm Control Center (NCC) for monitoring, documentation and control see page 78
- Visualization of loaded positions on the human machine interface (HMI)



Directly gas-fired rotary hearth furnaces with Tmax 1300 °C



Electrically heated rotary hearth furnaces with Tmax 450 °C, prepared for automatic operation

Continuous Furnaces

Electrically Heated or Gas-Fired



Continuous furnace plant for working temperatures up to 260 °C with integrated cooling station

Continuous furnace D 1500/3000/300/14 for thermal ageing with mesh belt transport system and subsequent cooling station



Continuous furnaces are the right choice for processes with fixed cycle times such as drying or preheating, curing, aging, vulcanisation or degassing. The furnaces are available for various temperatures up to a maximum of 1400 °C. The furnace design depends on the required throughput, the process requirements for heat treatment and the required cycle time.

The conveyor technology is tailored to the required working temperature, geometry and weight of the charge and to the requirements regarding available space and integration into the process chain. The conveyor speed and the number of control zones are defined by the process specifications.



Continuous furnace for bulk materials in baskets

Roller continuous furnace N 650/45 AS for heat treatment of heavy workparts



Continuous Furnaces

Electrically Heated or Gas-Fired



Heat treatment plant D 1600/6100/800/26AS according to EN 1539 with cooling station KS 1600/6100/800/AS for vulcanization processes of hoses



Mesh belt drive in a continuous furnace

- Conveyor concepts
- Conveyor belt
 - Metal conveyor belt with adjusted mesh gauges
 - Drive chain
 - Roller conveyors
 - Paternoster
 - Pusher-type
 - Rotary hearth

- Heating systems
- Electric heating, radiation or convection
 - Direct or indirect gas-fired
 - Infrared heating
 - Heating with the use of external heat sources



Continuous furnace D 700/10000/300/45S with chain conveyor for 950 °C, gas-fired



Continuous furnace D 1100/5800/100/50 AS for annealing of springs

Temperature cycles

- Control of working temperature across the whole length of the furnace, such as for drying or preheating
- Automatic control of a process curve applying defined heat-up, dwell and cooling time
- Heat treatment including a final quenching of the charge

Process atmosphere

- In air
- For processes with organic outgassings incl. mandatory safety technology according to EN 1539 (NFPA 86)
- In non-flammable protective or reactive gases such as nitrogen, argon or forming gas
- In flammable protective or reactive gases such as hydrogen incl. the necessary safety technology

Basic configuration criteria

- Conveyor speed
- Temperature uniformity
- Operating temperature
- Process curve
- Work space width
- Charge weights
- Cycle time or throughput
- Length of charge and discharge zone
- Generated exhaust gases
- Specific industry standards such as AMS, CQI-9, FDA etc.
- Other individual customer requirements



Mesh belt drive in continuous furnace D 1100/3600/100/50 AS



Rotary hearth furnace for preheating

Temperature Uniformity and System Accuracy

Temperature uniformity is defined as the maximum temperature deviation in the work space of the furnace. There is a general difference between the furnace chamber and the work space. The furnace chamber is the total volume available in the furnace. The work space is smaller than the furnace chamber and describes the volume which can be used for charging.

Specification of Temperature Uniformity in +/- K in the Standard Furnace

In the standard design the temperature uniformity is specified in +/- K at a defined set-temperature with the work space of the empty furnace during the dwell time. In order to make a temperature uniformity survey the furnace should be calibrated accordingly. As standard our furnaces are not calibrated upon delivery.

Calibration of the Temperature Uniformity in +/- K

If an absolute temperature uniformity at a reference temperature or at a defined reference temperature range is required, the furnace must be calibrated appropriately. If, for example, a temperature uniformity of +/- 5 K at a set temperature of 750 °C is required, it means that measured temperatures may range from a minimum of 745 °C to a maximum of 755 °C in the work space.

System Accuracy

Tolerances may occur not only in the work space, they also exist with respect to the thermocouple and in the controls. If an absolute temperature uniformity in +/- K at a defined set temperature or within a defined reference working temperature range is required, the following measures have to be taken:

- Measurement of total temperature deviation of the measurement line from the controls to the thermocouple
- Measurement of temperature uniformity within the work space at the reference temperature or within the reference temperature range
- If necessary, an offset is set at the controls to adjust the displayed temperature at the controller to the real temperature in the furnace
- Documentation of the measurement results in a protocol

Temperature Uniformity in the Work Space incl. Protocol

In standard furnaces a temperature uniformity is guaranteed as +/- K without measurement of temperature uniformity. However, as additional feature, a temperature uniformity measurement at a reference temperature in the work space compliant with DIN 17052-1 can be ordered. Depending on the furnace model, a holding frame which is equivalent in size to the charge space is inserted into the furnace. This frame holds thermocouples at defined measurement positions (11 thermocouples with square cross-section, 9 thermocouple with circular cross-section). The temperature uniformity measurement is performed at a reference temperature specified by the customer at a pre-defined dwell time. If necessary, different reference temperatures or a defined reference working temperature range can also be calibrated.



Holding frame for measurement of temperature uniformity



Pluggable frame for measurement for forced convection chamber furnace N 7920/45 HAS



Precision of the controls, e.g. +/- 1K

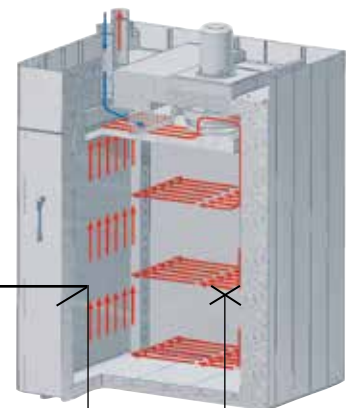

Deviation of thermocouple, e.g. +/- 1.5 °C

Deviation from measuring point to the average temperature in the work space e.g. +/-3 °C

The system accuracy is defined by adding the tolerances of the controls, the thermocouple and the work space

AMS 2750 E, NADCAP, CQI-9

Standards such as the AMS 2750 E (Aerospace Material Specifications) are applicable for the industrial processing of high-quality materials. They define industry-specific requirements for heat treatment. Today, the AMS 2750 E and derivative standards such as AMS 2770 for the heat treatment of aluminum are the guidelines for the aerospace industry. After the introduction of the CQI-9, the automotive industry has also committed to submit heat treatment processes to stricter rules. These standards describe in detail the requirements applicable to thermal processing plants.

- Temperature uniformity in the work space (TUS)
- Instrumentation (definition of measurement and control systems)
- Calibration of the measurement system (IT) from the controller via the measurement line to the thermocouple.
- Inspections of system accuracy (SAT)
- Documentation of the inspection cycles

Norm compliance is necessary to ensure that the required quality standard of the manufactured components can also be reproduced in series. For this reason, extensive and repeated inspections as well as controls of the instrumentation, including the relevant documentation, are required.

Furnace Class and Instrumentation Requirements of the AMS 2750 E

Depending on the quality requirements of heat treatment job the customer specifies instrumentation type and the temperature uniformity class. The instrumentation type describes the necessary combination of the applied control, recording media as well as thermocouples. The temperature uniformity of the furnace and the class of the selected instrumentation are defined based on the required furnace class. The higher the requirements are set for the furnace class the more precise the instrumentation must be.

Instrumentation	Type					Furnace class	Temperature uniformity	
	A	B	C	D	E		°C	°F
Each control zone has a thermocouple connected to the controller	x	x	x	x	x	1	+/- 3	+/- 5
Recording of the temperature measured by the control thermocouple	x	x	x	x		2	+/- 6	+/- 10
Sensors for recording the coldest and hottest spots	x		x			3	+/- 8	+/- 15
Each control zone has a charge thermocouple with recording system	x	x				4	+/- 10	+/- 20
Each control zone has an over-temperature protection unit	x	x	x	x		5	+/- 14	+/- 25
						6	+/- 24	+/- 50



Measurement set-up in a high-temperature furnace



Measurement set-up in an annealing furnace

Regular Inspections

The furnace or the heat treatment plant must be designed so that the requirements of the AMS 2750 E can be met and be reproduced. The standard also requires the inspection intervals for the instrumentation (SAT = System Accuracy Test) and the temperature uniformity of the furnace (TUS = Temperature Uniformity Survey). The SAT/TUS tests must be performed by the customer with measuring devices and sensors which operate independently of the furnace instrumentation.

Nabertherm Services

The suitable furnace model for the corresponding heat treatment can be designed based on the process, the charge, the required furnace class and the type of instrumentation. Depending on the required specs, alternative solutions can be offered.

- Furnace designs, which meet standards, following customer specifications regarding furnace class and instrumentation, incl. gauge connections for repeated customer inspections at regular intervals. No consideration of requirements with respect to documentation
- Data recording devices (e.g., temperature recorder) for TUS and/or SAT measurements see page 80
- Data recording, visualization, time management via the Nabertherm Control Center (NCC), based on Siemens WinCC software see page 78
- Commissioning at site, incl. the first TUS and SAT inspection
- Connection of existing furnace plant to meet norm requirements
- Documentation of the complete process chain in line with the corresponding norm

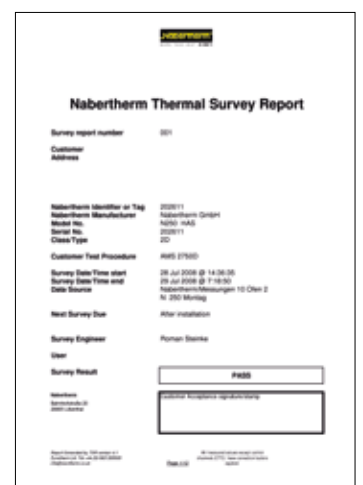

AMS 2750 E, NADCAP, CQI-9



Implementation of AMS 2750 E

Basically, two different systems are available for control and documentation, a proven Nabertherm system solution or instrumentation using Eurotherm controllers/temperature recorders. The Nabertherm AMS package is a convenient solution that includes the Nabertherm Control Center for control, visualization, and documentation of the processes and test requirements based on PLC control.

Instrumentation with Nabertherm Control Center (NCC) for Control, Visualization, and Documentation based on a Siemens PLC Controls

The attractive feature of the instrumentation with Nabertherm Control Center in combination with PLC controls of the furnace is the convenient data input and visualization. The software programming is structured in a way that both the user and the auditor can navigate it without difficulty.

In daily use, the following product characteristics stand out:

- Very easy to navigate and straight-forward presentation of all the data in plain text on the PC
- Automatic saving of the charge documentation at the end of the program
- Administration of the calibration cycles in the NCC
- Results of the measurement distance calibration are entered in the NCC
- Schedule management of the required testing cycles including a reminder function. The testing cycles for TUS (Temperature Uniformity Survey) and SAT (System Accuracy Test) are entered in days and monitored by the system and the operator or tester is informed in time about up-coming tests. The measurements have to be done with separate calibrated measuring equipment.
- Option of transferring the measurement data to a customer's server

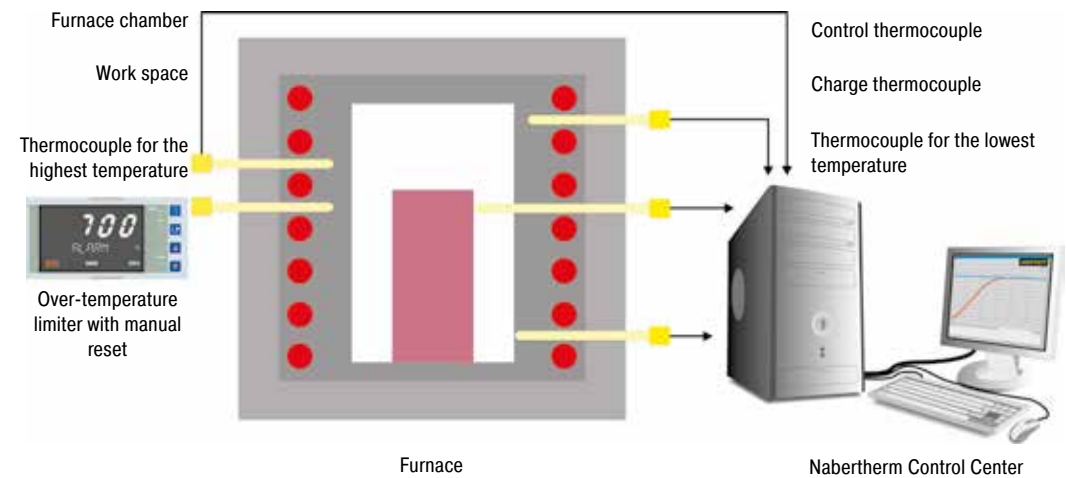

Example of a design with Type A Nabertherm Control Center



The Nabertherm Control Center can be extended to enable a complete documentation of the heat treatment process apart from just the furnace data. For example, when heat-treating aluminum, in addition to the furnace, the temperatures in the quenching basin or a separate cooling medium can also be documented.

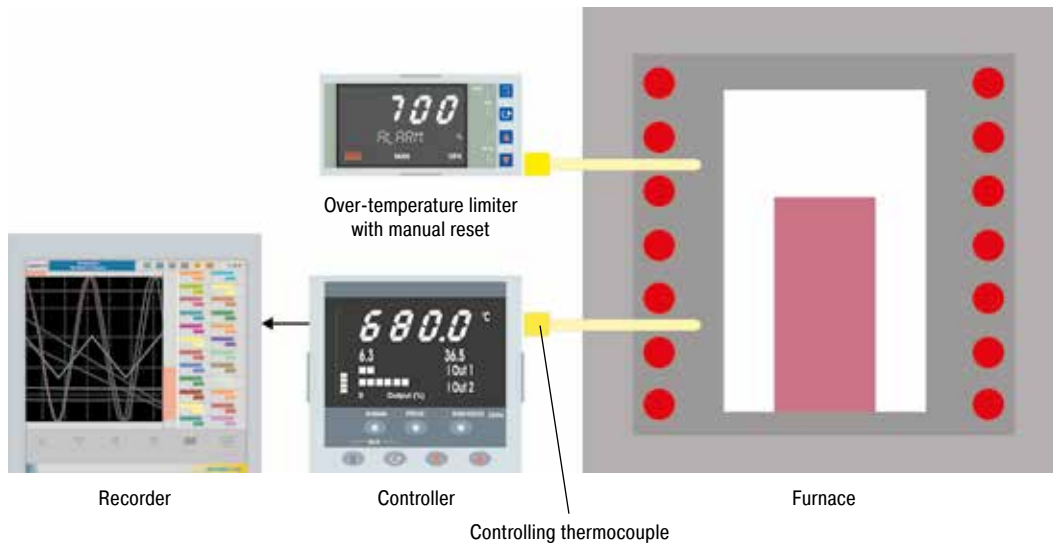

Example of a design containing Type D Eurotherm instrumentation



N 12012/26 HAS1 according to AMS 2750 E

Alternative Instrumentation with Temperature Controllers and Recorders from Eurotherm

As an alternative to instrumentation with the Nabertherm Control Center (NCC) and PLC controls, instrumentation with controllers and temperature recorders is also available. The temperature recorder has a log function that must be configured manually. The data can be saved to a USB stick and be evaluated, formatted, and printed on a separate PC. Besides the temperature recorder, which is integrated into the standard instrumentation, a separate recorder for the TUS measurements is needed (see page 78).

Furnace Chamber Control

Only the furnace chamber temperature is measured and controlled. Regulation is carried out slowly to avoid out-of-range values. As the charge temperature is not measured and controlled, it may vary a few degrees from the chamber temperature.

Charge Control

If the charge control is switched on, both the charge temperature and furnace chamber temperature are measured. By setting different parameters the heat-up and cooling processes can be individually adapted. This results in a more precise temperature control at the charge.

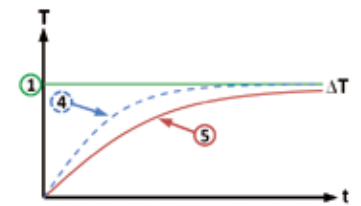

Furnace control

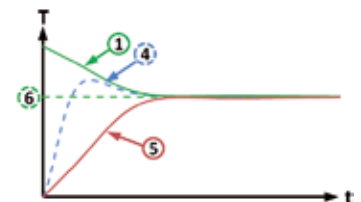

Charge control

- 1. Furnace setpoint value
- 2. Actual value furnace chamber, 1-zone
- 3. Actual value furnace chamber, 3-zone
- 4. Actual value furnace chamber
- 5. Actual value load/bath/muffle/retort
- 6. Charge setpoint value

Process Control and Documentation



B400/C440/P470



B410/C450/P480



H1700 with colored, tabular depiction



H3700 with colored graphic presentation

Nabertherm has many years of experience in the design and construction of both standard and custom control alternatives. All controls are remarkable for their ease of use and even in the basic version have a wide variety of functions.

Standard Controllers

Our extensive line of standard controllers satisfies most customer requirements. D60Based on the specific furnace model, the controller regulates the furnace temperature reliably and is equipped with an integrated USB-interface for documentation of process data (NTLog/NTGraph).

The standard controllers are developed and fabricated within the Nabertherm group. When developing controllers, our focus is on ease of use. The user can choose between 17 languages. From a technical standpoint, these devices are custom-fit for each furnace model or the associated application. From the simple controller with an adjustable temperature to the control unit with freely configurable control parameters, stored programs and PID microprocessor control with self-diagnosis system, we have a solution to meet your requirements.

HiProSystems Control and Documentation

This professional process control with PLC controls for single and multi-zone furnaces is based on Siemens hardware and can be adapted and upgraded extensively. HiProSystems control is used when more than two process-dependent functions, such as exhaust air flaps, cooling fans, automatic movements, etc., have to be handled during a cycle, when furnaces with more than one zone have to be controlled, when special documentation of each batch is required and when remote service is required. It is flexible and is easily tailored to your process or documentation needs.

Alternative User Interfaces for HiProSystems

Process control H500/H700

This basic panel accommodates most basic needs and is very easy to use. Firing cycle data and the extra functions activated are clearly displayed in a table. Messages appear as text. Data can be stored on a USB stick using the „NTLog Comfort“ option (not available for all H700).

Process control H1700

Customized versions can be realized in addition to the scope of services of the H500/H700

Process control H3700

Display of functions on a large 12“ display. Display of basic data as online trend or as a graphical system overview. Scope as H1700

Control, Visualisation and Documentation with Nabertherm Control Center NCC

Upgrading the HiProSystems-Control individually into a PC-based NCC provides for additional interfaces, operating documentation, and service benefits in particular for controlling furnace groups including charge beyond the furnace itself (quenching tank, cooling station etc.):

- Recommended for heat treatment processes with extensive requirements in respect to documentation e.g. for metals, technical ceramics or in the medicine field
- Software extension can be used also in accordance with the AMS 2750 E (NADCAP)
- Documentation according to the requirements of Food and Drug Administration (FDA), Part 11, EGV 1642/03 possible
- Charge data can be read in via barcodes
- Interface for connection to overriding systems
- Connection to mobile phone or stationary network for malfunction message transmission via SMS
- Control from various locations over the network
- Measurement range calibration up to 18 temperatures per measuring point for use at different temperatures. For norm-relevant applications a multilevel calibration is possible.

Assignment of Standard Controllers to Furnace Families	KB	KBR	K 10/12 - K 80/13	TB	TBR	T .. /11, T .. /12, T .. /13	KC	TC	T .. /10	TM	B	K 1/.. - K 4/..	SRO	KTR	NA 30/45(LS) - N 675/85HA	N 1000/26HA - N 4000/85HA	W .. A	SAH	FS	NB .. CL	N(B) .. BO	N .. /WAX	NB 300/BOWAX	W
Catalog page Controller	8	11	12	14	16	18	20	20	22	23	24	32	33	34	38	40	44	46	48	56	57	58	59	60
R7																								
3208	●	●	●	●	●	●			●	●	●	●		○	○	○								
3504	○	○	○	○	○	○			○	○		○		○	○	○								
3508							●	●																
B400																						●		●
B410													●											
C440																								
P470																								○
H500/PLC	○	○	○	○	○	○	○	○	○	○					○	○	○	○						○
H700/PLC	○	○	○	○	○	○	○	○	○	○					○	○	○	○						○
H1700/PLC																			●	●	●	○	●	○
H3700/PLC																			○	○	○	○	○	○
NCC																			○	○	○	○	○	○

Functionality of the Standard Controllers

	R7	3216	3208	B400/ B410	C440/ C450	P470/ P480	3504	H500	H700	H1700	H3700	NCC
Number of programs	1	1		5	10	50	25	20	1/10 ³	10	10	50
Segments	1	8		4	20	40	500 ³	20	20	20	20	20
Extra functions (e.g. fan or autom. flaps) maximum				2	2	2-6	2-8 ³	3 ³	○ ³	6/2 ³	8/2 ³	16/4 ³
Maximum number of control zones	1	1	1	1	1	3	2 ^{1,2}	1-3 ³	○ ³	8	8	8
Drive of manual zone regulation				●	●	●						
Charge control/bath control							○	○	○	○	○	○
Auto tune		●	●	●	●	●	●					
Real-time clock				●	●	●		●	●	●	●	●
Plain, blue-white LC-display				●	●	●						
Graphic color display								4" 7"	7"	7"	12"	19"
Status messages in clear text				●	●	●	●	●	●	●	●	●
Data entry via touchpanel								●	●	●	●	
Data input via jog dial and buttons				●	●	●						
Entering program names (i.e. "Sintering")				●	●	●						●
Keypad lock				●	●	●	●					
User administration				●	●	●		○	○	○	○	●
Skip-button for segment jump				●	●	●		○	○	○	○	●
Program entry in steps of 1 °C or 1 min.	●	●	●	●	●	●	●	●	●	●	●	●
Start time configurable (e.g. to use night power rates)				●	●	●	●	●	●	●	●	●
Switch-over °C/°F	○	○	○	●	●	●	○	●	● ³	● ³	● ³	● ³
kWh meter				●	●	●						
Operating hour counter				●	●	●		●	●	●	●	●
Set point output				○	●	●	○		○	○	○	○
NTLog Comfort for HiProSystems: recording of process data on an external storage medium				●	●	●		○	○	○	○	
NTLog Basic for Nabertherm controller: recording of process data with USB-flash drive				○	○	○						
Interface for VCD software				●	●	●						
Malfunction memory				●	●	●		●	●	●	●	●
Number of selectable languages				17	17	17						

¹ Not for melt bath control

² Control of additional separate slave regulators possible

³ Depending on the design

● Standard
○ Option

Mains Voltages for Nabertherm Furnaces

1-phase: all furnaces are available for mains voltages from 110 V - 240 V at 50 or 60 Hz.

3-phase: all furnaces are available for mains voltages from 200 V - 240 V or 380 V - 480 V, at 50 or 60 Hz.

The connecting rates in the catalog refer to the standard furnace with 400 V (3/N/PE) respectively 230 V (1/N/PE).

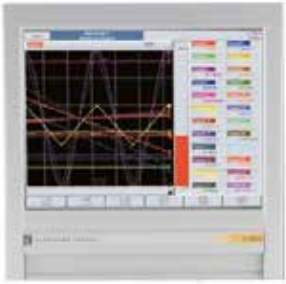

Temperature recorder

Temperature Recorder

Besides the documentation via the software which is connected to the controls, Nabertherm offers different temperature recorders which can be used with respect to the application.

	Model 6100e	Model 6100a	Model 6180a
Data input using touch panel	X	X	X
Size of colour display in inch	5.5	5.5	12.1
Number of thermocouple inputs	3	18	48
Data read-out via USB-stick	X	X	X
Input of charge data		X	X
Evaluation software included	X	X	X
Applicable for TUS-measurements acc. to AMS 2750 E			X



Data storing of Nabertherm controllers with NTLog Basic

NTLog Basic allows for recording of process data of the connected Nabertherm Controller (B400, B410, C440, C450, P470, P480) on a USB stick.

The process documentation with NTLog Basic requires no additional thermocouples or sensors. Only data recorded which are available in the controller.

The data stored on the USB stick (up to 80,000 data records, format CSV) can afterwards be evaluated on the PC either via NTGraph or a spreadsheet software used by the customer (e.g. MS Excel).

For protection against accidental data manipulation the generated data records contain checksums.



Data storing of HiProSystems with NTLog Comfort

The extension module NTLog Comfort offers the same functionality of NTLog Basic module. Process data from a HiProSystems control are read out and stored in real time on a USB stick (not available for all H700 systems). The extension module NTLog Comfort can also be connected using an Ethernet connection to a computer in the same local network so that data can be written directly onto this computer.



NTLog Comfort for data recording of a Siemens PLC

Visualization with NTGraph for Single-Furnace Control

The process data from NTLog can be visualized either using the customer's own spreadsheet program (e.g. MS-Excel) or NTGraph (Freeware). With NTGraph Nabertherm provides for an additional user-friendly tool free of charge for the visualization of the data generated by NTLog. Prerequisite for its use is the installation of the program MS-Excel for Windows (version 2003/2010/2013). After data import presentation as diagram, table or report can be chosen. The design (color, scaling, reference labels) can be adapted by using prepared sets. NTGraph is available in seven languages (DE/EN/FR/SP/IT/CH/RU). In addition, selected texts can be generated in other languages.



Software NTEdit for Entering Programs on the PC

By using the software NTEdit (Freeware) the input of the programs becomes clearer and thus easier. The program can be entered on customers PC and then be imported into the controller with a USB stick. The display of the set curve is tabular or graphical. The program import in NTEdit is also possible. With NTEdit Nabertherm provides a user-friendly free tool. A prerequisite for the use is the client installation of MS-Excel for Windows (2007/2010/2013). NTEdit is available in eight languages (DE/EN/FR/SP/IT/CH/RU/PT).

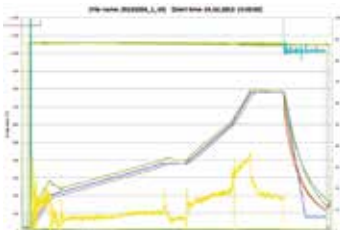

NTGraph, a freeware for the easy-to-read analysis of recorded data using MS Excel

VCD-Software for Visualization, Control and Documentation

Documentation and reproducibility are more and more important for quality assurance. The powerful VCD software represents an optimal solution for single multi furnace systems as well as charge documentation on the basis of Nabertherm controllers.

The VCD software is used to record process data from the controllers B400/B410, C440/C450 and P470/P480. Up to 400 different heat treatment programs can be stored. The controllers are started and stopped via the software at a PC. The process is documented and archived accordingly. The data display can be carried-out in a diagram or as data table. Even a transfer of process data to MS Excel (.csv format *) or the generation of reports in PDF format is possible.

Features

- Available for controllers B400/B410/C440/C450/P470/P480
- Suitable for operating systems Microsoft Windows 7 or 8/8.1 or 10 (32/64 Bit)
- Simple installation
- Setting, Archiving and print of programs and graphics
- Operation of controllers via PC
- Archiving of process curves from up to 16 furnaces (also multi-zone controlled)
- Redundant saving of archives on a server drive
- Higher security level due to binary data storage
- Free input of charge date with comfortable search function
- Possibility to evaluate data, files can be converted to Excel
- Generation of a PDF-report
- 17 languages selectable

Extension package 1 for display of an additional temperature measuring point, independant of the furnace controls

- Connection of an independant thermocouple, type S, N or K with temperature display on controller C6D, e. g. for documentation of charge temperature
- Conversion and transmission of measured values to the VCD software
- For data evaluation, please see VCD-software features
- Display of measured temperature directly on the extension package

Extension package 2 for the connection of up to three, six or nine measuring point, independant of the furnace controls

- Connection of three thermocouples, tpye K, S, N or B to the included connecting box
- Possible extension of up to two or three connecting boxes with up to nine measuring points
- Conversion and transmission of measured values to the VCD software
- Data evaluation, see VCD features



Example lay-out with 3 furnaces



VCD Software for Control, Visualisation and Documentation



Graphic display of main overview (version with 4 furnaces)

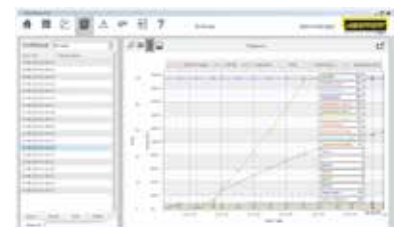

Graphic display of process curve

Additive Manufacturing



Retort furnace NR 150/11 for annealing of metal parts of 3D-printing



Oven TR 240 for drying of powders



Chamber oven KTR 2000 for curing after 3D-printing



Compact tube furnace for sintering or annealing under protective gases or in a vacuum after 3D-printing



HT 160/17 DB200 for debinding and sintering of ceramics after 3D-printing

Additive manufacturing allows for the direct conversion of design construction files fully functional objects. With 3D-printing objects from metals, plastics, ceramics, glass, sand or other materials are built-up in layers until they have reached their final shape.

Depending on the material, the layers are interconnected by means of a binder system or by laser technology.

Many methods of additive manufacturing require subsequent heat treatment of the manufactured components. The requirements for the furnaces for heat treatment depend on the component material, the working temperature, the atmosphere in the furnace and, of course, the additive production process.

Nabertherm offers solutions from curing for conservation of the green strength up to sintering in vacuum furnaces in which the objects of metal are annealed or sintered.

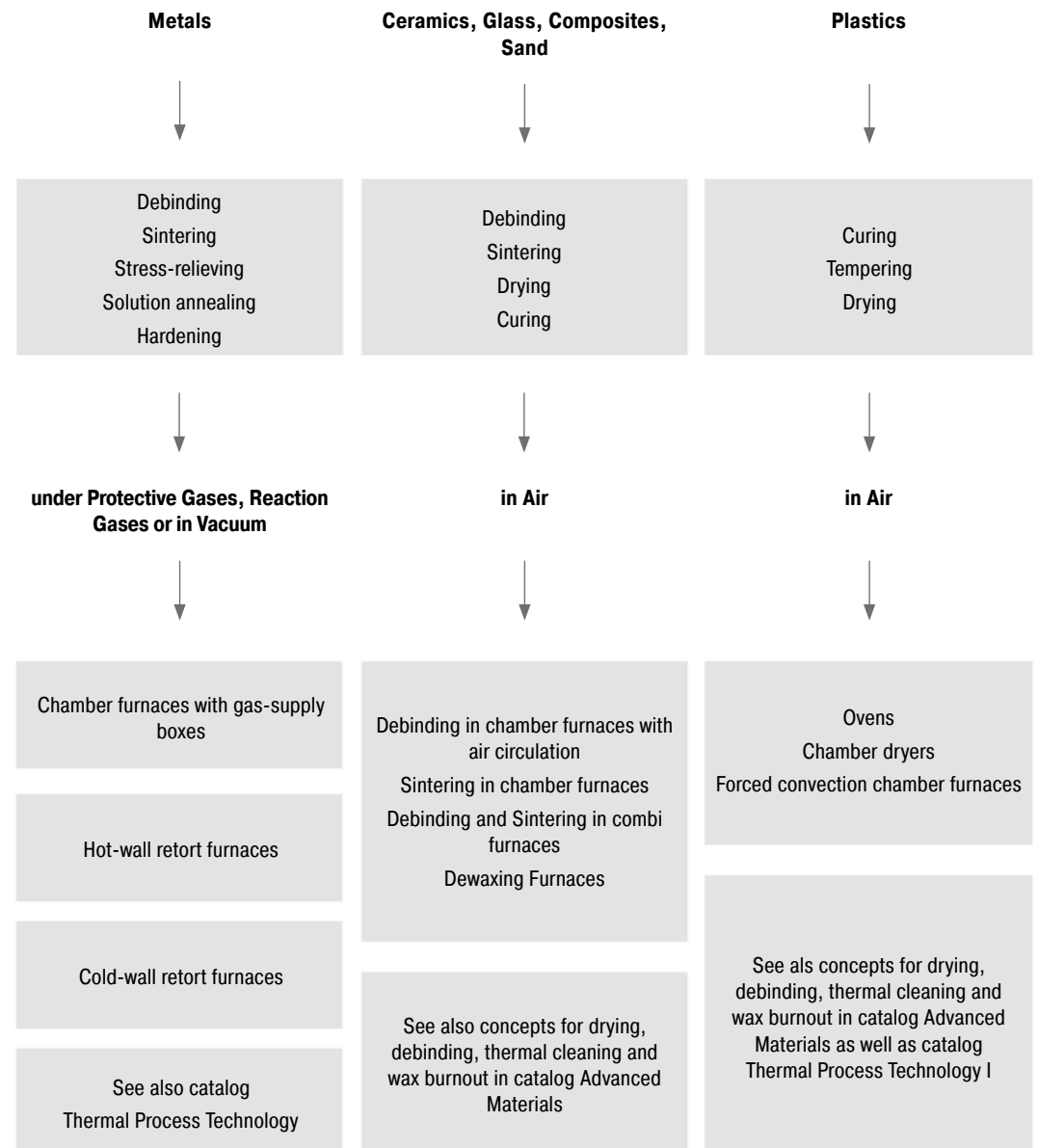

Also, concomitant or upstream processes of additive manufacturing require the use of a furnace in order to achieve the desired product properties, such as heat treatment or drying the powder.

Energy Efficiency Technology

In face of rising energy prices and stricter environmental regulations there is increasing demand for heat treatment plants with greater energy efficiency.

Depending on the furnace size and the process there is always a certain amount of potential energy which can be recovered from the waste heat and re-used. This is especially true for large furnace systems or long process times which allow for huge energy savings that the additional investment has a short pay-back time. The thermal energy from finished charges can also be used to pre-heat cold charges which is also an efficient way of saving energy.

The following examples outline engineering alternatives for heat recovery:

Heat Exchangers

The principle of the counterflow heat exchanger is to use the hot exhaust gas coming from the furnace to pre-heat the cold fresh air channelled into the furnace. In many cases, there is no need anymore for a separate fresh air preheating unit. Such a system is recommended if the process requires continuous air exchange in the furnace chamber, such as when tempering silicone, or during drying processes that are covered by the EN 1539 industrial standard.

Recuperator Burners

Large gas-heated heat-treatment furnaces are especially advantageous for the installation of recuperator burners. Recuperator burners also use hot exhaust gas; to pre-heat the combustion air. Depending on the furnace model and the process, substantial energy savings of as much as 25% can be realized by using recuperator burners so that there is a short pay-back time for the additional purchase costs.

Heat Transfer Chambers

Heat transfer chambers, which can also be described as cooling/heating chambers, offer two enormous advantages. For one, they help save energy, and for another, using a heat transfer chamber increases productivity.

The load is removed from the furnace while it is still hot and placed in the heat transfer chamber. The chamber also has room for a new, cold charge. Circulating the air cools the hot charge and, at the same time, preheats the cold charge before it is put into the furnace. Consequently, the furnace heating does not have to provide the thermal energy and through-put capacity of the furnace is increased of the same time.

The above systems for enhancing energy efficiency are only a few examples of technical alternatives. We would be happy to advise you on whether an additional heat recovery module would also be a sensible add-on to your furnace or system.



Counterflow heat exchanger for the forced convection chamber furnace N 2560/26 ACLS



Recuperator burner for aluminum melting furnace 16 x TBR 110/12 and 2 x TBR 180/12



Heat transfer between a hot and a cold charge



Production system, consisting of four chamber furnaces for moving the load during heat treatment along with a three-stage heat exchanger to optimize energy efficiency

The whole World of Nabertherm: www.nabertherm.com

Please visit our website

www.nabertherm.com and find out all you want to know about us - and especially about our products.

Besides news and our current calendar of trade fairs, there is also the opportunity to get in touch directly with your local sales office or nearest dealer worldwide.

Professional Solutions for:

- Arts & Crafts
- Glass
- Advanced Materials
- Laboratory
- Dental
- Thermal Process Technology for Metals, Plastics and Surface Finishing
- Foundry



Headquarters:

Nabertherm GmbH
Bahnhofstr. 20
28865 Lilienthal, Germany
contact@nabertherm.de

Sales Organisation

China
Nabertherm Ltd. (Shanghai)
150 Lane, No. 158 Pingbei Road, Minhang District
201109 Shanghai, China
contact@nabertherm-cn.com

France
Nabertherm SARL
20, Rue du Cap Vert
21800 Quetigny, France
contact@nabertherm.fr

Italy
Nabertherm Italia
via Trento N° 17
50139 Florence, Italy
contact@nabertherm.it

Great Britain
Nabertherm Ltd., United Kingdom
contact@nabertherm.com

Switzerland
Nabertherm Schweiz AG
Altgraben 31 Nord
4624 Härkingen, Switzerland
contact@nabertherm.ch

Spain
Nabertherm España
c/Marti i Julià, 8 Bajos 7ª
08940 Cornellà de Llobregat, Spain
contact@nabertherm.es

USA
Nabertherm Inc.
54 Read's Way
New Castle, DE 19720, USA
contact@nabertherm.com



All other Countries: Follow
<http://www.nabertherm.com/contacts>

www.nabertherm.com

■ Made
■ in
■ Germany